

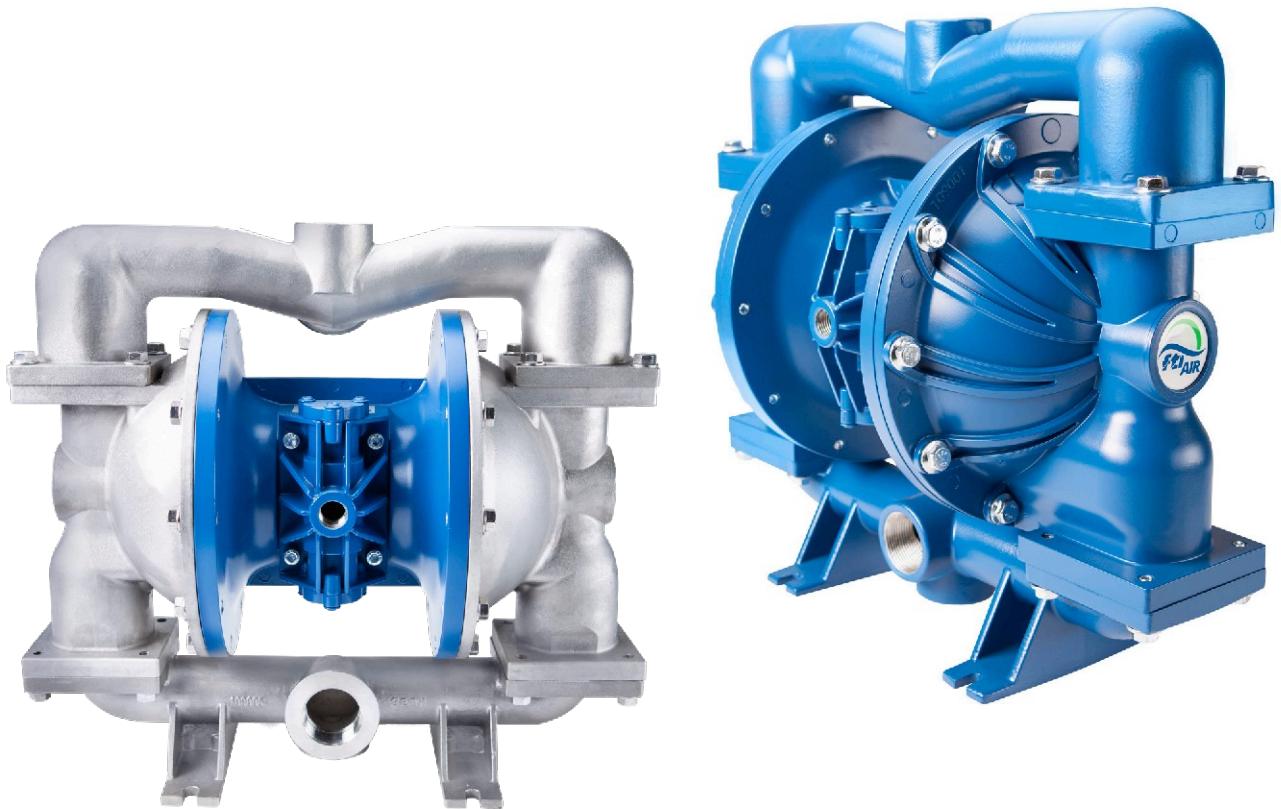

FTI AIR AODD MODELS FT15ZA & FT15ZS

Assembly, Installation, & Operation Manual

P/N 109875 R5



Record your Model and Serial Number here.

MODEL NUMBER _____

SERIAL NUMBER _____



A DIVISION OF FINISH THOMPSON INC.
921 Greengarden Rd • Erie, PA 16501 USA
Ph: 814-455-4478 • Fax: 814-455-8518
www.ftiair.com

EU Declaration of Conformity



FTI Air hereby declares that the following machine(s) fully comply with the applicable health and safety requirements as specified by the EC Directives listed. The complete product complies with the provisions of the EC Directive on machinery safety.

This declaration is valid provided that the devices are fully assembled and no modifications are made to these devices.

Type of Device:

Air Operated Double Diaphragm Pumps

Models:

FT025P, FT025V, FT025C, FT05P, FT05V, FT05A, FT05S,
FT10P, FT10V, FT10A, FT10S, FT15P, FT15V, FT15A, FT15S, FT15ZP, FT15ZV, FT15ZA, FT15ZS,
FT20P, FT20V, FT20A, FT20S, FT30A & FT30S

EC Directives:

Machinery Safety (2006/42/EC)

Applied Harmonized Standards:

EN ISO 12100

Manufacturer:

FTI Air A Division of Finish Thompson, Inc.
921 Greengarden Road
Erie, Pennsylvania 16501-1591 U.S.A

Signed,

President

23 May 2019

Person(s) Authorized to Compile Technical File: FTI Air GmbH
Otto-Hahn-Strasse 16
Maintal, D-63477 DEU
Telephone: 49 (0)6181-90878-0

EU Declaration of Conformity

Manufactured by:

Finish Thompson, Inc.
921 Greengarden Road
Erie, Pennsylvania 16501 U.S.A.
Phone: 1-(814)-455-4478
Fax 1-(814)-455-8518
Email: fti@finishthompson.com
Web: www.finishthompson.com



This declaration applies to **FTI Air ATEX Series** AODD pumps, being designated by the letter -A- in the model number, and only manufactured out of metallic or carbon fiber filled PP designated by the model numbers FTXX[Z]A, FTXX[Z]S, or FTXX[Z]C, with metallic or carbon fiber filled non-wetted parts designated by the letters -AA- or -CD- within the model number. Pumps and their model numbers may also contain different combinations of diaphragms, balls, seats, o-rings, port connections, and other options.

Example Model Numbers: FT05C-CD-2TPC-B1-A, FT05A-AA-NNAN-B1-A, FT15ZA-AA-BBAB-B2-A

Finish Thompson declares under our sole responsibility that the product listed below conforms to the relevant provisions of EU directive 2014/34/EU of 26 February 2014 for equipment and protective systems intended for use in potentially explosive atmospheres, and is certified for safe use in Group II category 2 areas.

This product has used the following harmonized standards to verify conformance:

Non-electrical equipment for potentially explosive atmospheres: EN ISO 80079-36:2016
Basic Methods and Requirements.

Non-electrical equipment intended for use in potentially explosive atmospheres: EN ISO 80079-37:2016
Protection by construction safety "ch" and control of ignition source "bh".

This product must not be used in areas other than specified above. If in doubt consult an authorized distributor, or refer to the manufacturer Finish Thompson.

Approved by:

Date: 05/23/2019

Table of Contents

Important Information - READ ME FIRST

Export Regulation Notice	5
Chemical Reaction Disclaimer	5
Safety Precautions	5-6

Pump Specifications

Materials Profiles.....	7
Technical Specifications	7
FT10S Dimensional Drawing.....	8
Model Number Explanation & Example Part Numbers.....	8
FT10A Dimensional Drawing.....	9
Performance Curve.....	9

Installation/Operation

Installation Drawing.....	10
Precautions.....	10-11
Troubleshooting.....	11

Maintenance

Recommended Tools	11
Wet End Servicing	11
Disassembly	12-13
Reassembly	14-17
Air End Servicing	17
Shaft Bushing & O-ring Replacement.....	17-18
Air Valve O-ring Replacement.....	18-19
Valve Gasket Replacement.....	19-20
Air Valve Slide, Plate, & Gasket Orientation.....	20
Replacement Air Valve Kit Installation.....	21
Exploded View	21
Spare Parts List.....	21-25

Warranty	26
-----------------------	-----------

Important Information- Read Me first

IMPORTANT NOTICE

U.S. Export Administration Regulations, pursuant to ECCN 2B350, prohibit the export or re-export to certain enumerated countries of air operated double diaphragm pumps in which all wetted materials are constructed from fluoropolymers without first applying for and obtaining a license from the U.S. Bureau of Industry and Security (BIS). This affects all FTI AIR pumps constructed from PVDF with PTFE balls and diaphragms. Please contact the BIS (www.bis.doc.gov) or FTI Air with questions regarding the Regulations or a list of the countries to which they apply.

Chemical Reaction Disclaimer

The user must exercise primary responsibility in selecting the product's materials of construction which are compatible with the fluid(s) that come(s) in contact with the product. The user may consult FTI Air (manufacturer) and a manufacturer's representative/distributor agent to seek a recommendation of the product's material of construction that offers the optimum available chemical compatibility.

However neither manufacturer nor agent shall be liable for product damage or failure, injuries, or any other damage or loss arising out of a reaction, interaction or any chemical effect that occurs between the materials of the product's construction and fluids that come into contact with the product's components.

Unpacking & Inspection

Unpack the pump and examine for any signs of shipping damage. If damage is detected, save the packaging and notify the carrier immediately.

To install the pump, follow the installation instructions provided.

Safety Precautions for ATEX Pumps

⚠ Warning: READ THIS SUPPLEMENTAL INSERT COMPLETELY BEFORE INSTALLING AND OPERATING THIS PUMP. FAILURE TO FOLLOW THESE PRECAUTIONS CAN RESULT IN SERIOUS INJURY OR DEATH.

⚠ WARNING: Static sparking can cause explosion. When operating in a hazardous area or pumping a hazardous fluid, the pump's grounding screw and entire pump system must be grounded to earth to prevent static discharge. This includes but is not limited to pipes, hoses, tanks, containers, valves, etc. Before operating the pump, ensure the electrical continuity throughout the pumping system and earth ground is 1 Ohm or less. If it is greater than 1 Ohm, re-check all grounding connections.

⚠ WARNING: Static sparking can cause explosion. Excessive fluid flow rates and improper tank filling methods can produce static electricity causing an explosion. Ensure safe fluid velocities and tank filling procedures in compliance with EN 13463-1 and CLC/TR 50404.

⚠ WARNING: Vibrations from operation may cause mounting surfaces and connections to loosen and generate a spark. Ensure the pump and connections are securely mounted and fastened prior to each operation.

⚠ WARNING: Do not exceed minimum and maximum temperature limits of pump components. A table of temperature limits is provided in the "Pump Data" section of the manual.

⚠ WARNING: Prior to operating, check pump for any worn o-rings, gaskets, or seals. Any leaking or damaged o-rings, gaskets, or seals must be repaired or replaced immediately.

⚠ WARNING: Do not exceed maximum pressure stated on the pump serial number sticker.

⚠ WARNING: Pump exhaust may be loud and contain particles. Wear appropriate ear and eye protection. In the event of a diaphragm rupture material can be forced out of the air exhaust muffler. If product is hazardous or toxic, pipe exhaust to appropriate safe area.

⚠ WARNING: Pump must be cleaned on a regular basis to avoid dust buildup greater than 5mm.

⚠ WARNING: The surface temperature of the pump depends upon the temperature of the fluid that is being pumped. The chart below lists different fluid temperatures and the corresponding pump surface temperatures, which determine the Temperature Class when used in a hazardous area.

Fluid Temperature	Maximum Surface Temperature	Temperature Class	Maximum Allowable Surface Temperature
172° F (78° C)	172° F (78° C)	T6	85° C
203° F (95° C)	203° F (95° C)	T5	100° C
266° F (130° C)	266° F (130° C)	T4	135° C
383° F (195° C)	383° F (195° C)	T3	200° C

Safety Precautions

⚠ WARNING: FTI Air maximum temperature limits are based upon the material's mechanical stress only. Maximum temperature is application dependent. Consult a chemical resistance guide or the chemical manufacturer for chemical compatibility and temperature limits.

⚠ WARNING: Chemical Hazard. This pump is used for transferring many types of potentially dangerous chemicals. Always wear protective clothing, eye protection and follow standard safety procedures when handling corrosive or personally harmful materials. Proper procedures should be followed for draining and decontaminating the pump before disassembly and inspection of the pump. There may be small quantities of chemicals present during inspection.

⚠ WARNING: Hot surfaces. FTI Air pumps are capable of handling liquids with temperatures as high as 220°F (104°C). This may cause the outer areas of the pump to become hot as well and could cause burns.

⚠ WARNING: If a diaphragm rupture occurs, material being pumped may be forced out of the air exhaust. Proper care should be taken, always wear protective clothing, eye protection & follow standard safety procedures.

⚠ WARNING: When pumping hazardous liquids, or operating the pump in an enclosed room, it is important to pipe the exhaust air to a safe area.

⚠ WARNING: For polypropylene or PVDF pumps do not exceed 100 psig (6.9 bar) air supply & 120 psig (8.3 bar) for aluminum and stainless steel.

⚠ CAUTION: Before attaching air supply to pump to make sure all airline debris is clear. It is recommended to use a minimum 5µ (micron) air filter before the air valve.

⚠ CAUTION: Do not over-tighten the air inlet fitting or muffler. Too much torque could damage the air valve or muffler plate.

⚠ CAUTION: Before maintenance or repair, close the compressed air line supply valve, bleed the pressure and disconnect air line from the pump. Discharge line may also be pressurized. Any pressure must be relieved prior to servicing. Isolate and remove suction / discharge lines & drain the pump. Note that flooded suction systems could be subject to significant leaking through the exhaust before suction isolation valve is closed.

⚠ CAUTION: If pump is used with materials that tend to solidify or settle, the pump should be flushed after each use to prevent damage.

⚠ CAUTION: Use only genuine FTI Air replacement parts to assure compatibility & longest service life.

⚠ CAUTION: Check the temperature limits for all wetted components when choosing pump materials. See Materials Profiles table on page 7.

⚠ EXPLOSION HAZARD! FTI Air pumps with standard materials of construction should not be used with halogenated hydrocarbons. Halogenated hydrocarbon solvents can cause explosion when used with aluminum components in a closed (pressurized) system. FTI Air pumps with standard materials of construction contain aluminum components and will be affected by halogenated hydrocarbon solvents.

1-1-1 Trichloroethane and Methylene Chloride are the most common halogenated hydrocarbons. However, other halogenated hydrocarbon solvents are suspect if used either as part of paint or adhesive formulation, or for clean-up flushing. For applications that may involve halogenated hydrocarbons, contact FTI Air to discuss the availability of alternative pump materials of construction.

Material Profiles

Material	Chemical Composition	Description	Operating Temperature		Relative Cost
			Minimum	Maximum	
Polypropylene	Pure Polypropylene	Thermoplastic that is resistant to alkali and strong acids.	32°F (0°C)	158°F (70°C)	\$
PVDF	Pure Polyvinylidene Fluoride	Strong fluoropolymer with excellent chemical resistance.	10°F (-12°C)	220°F (104°C)	\$\$\$
Stainless Steel	316 Stainless Steel	Excellent chemical resistance, high tensile and impact strength, abrasion resistant.	Limited by other materials used		\$\$
Aluminum	ADC 12, LM24, LM25	Moderate chemical resistance with good impact strength and abrasion resistance.	Limited by other materials used		\$
Buna	Acrylonitrile-butadiene Rubber	General purpose elastomer. Resistant to oil, water, solvent, and hydraulic fluid.	10°F (-12°C)	190°F (88°C)	\$
EPDM	Ethylene Propylene Diene Rubber	Good resistance to mild acids, detergents, alkalis, ketones, and alcohols.	-40°F (-40°C)	250°F (121°C)	\$
FKM	Fluorocarbon Rubber	Good chemical resistance and high temperature properties. Resistant to most acids, aliphatic, aromatic, and halogenated hydrocarbons, oils, grease, and fuels.	-40°F (-40°C)	350°F (177°C)	\$\$
Neoprene	Chloroprene Rubber	General purpose elastomer with good resistance to moderate chemicals, oils, grease, solvents, and some refrigerants.	0°F (-18°C)	212°F (100°C)	\$
Santoprene™	Fully cured EPDM rubber particles encapsulated in a polypropylene (PP) matrix	Thermoplastic elastomer with good abrasion resistance with chemical resistance to a wide range of solvents and chemicals. Injection molded with no fabric layer.	-40°F (-40°C)	225°F (107°C)	\$
Hytrel®	Thermoplastic polyester elastomer	Combines resistance and flexibility of elastomers with the strength of plastics. Resistant to acids, bases, amines, and glycols. Injection molded with no fabric layer.	-20°F (-29°C)	220°F (104°C)	\$
Polyurethane	Polyester Urethane	Thermoplastic that exhibits excellent abrasion resistance. Injection molded with no fabric layer.	32°F (0°C)	150°F (66°C)	\$
PTFE	Polytetrafluoroethylene	Chemically inert. Resistant to a wide range of chemicals.	40°F (4°C)	225°F (107°C)	\$\$
FEP	Fluorinated Ethylene Propylene	Similar to PTFE in composition and chemical resistance. Used to encapsulate FKM o-rings for superior chemical resistance.	40°F (4°C)	225°F (107°C)	\$\$

Santoprene™ is a registered tradename of Exxon Mobil Corp.
 Hytrel® is a registered tradename of Dupont™

Specifications

Pump Type: Metallic Air Operated Double Diaphragm	
<p>Weight: Aluminum - 52 lbs (23.6 kg) 316SS - 98 lbs (44.5 kg)</p> <p>Air Inlet/Exhaust Size: 1/2" FNPT/3/4" FNPT</p> <p>Max Air Inlet Pressure: 120 psig (8.3 bar)</p> <p>Max Material Inlet Pressure: 10 psig (0.7 bar)</p> <p>Air Consumption @ 100 psi: 85 scfm (144 Nm³/hr)</p> <p>Noise Level: 77 dB(A)</p>	<p>Max Suction Lift: Wet - 28 ft H₂O (8.5 m H₂O) Dry - PTFE & Rubber: 18 ft H₂O (5.5 m H₂O) TPE: 14 ft H₂O (4.3 m H₂O)</p> <p>Max Flow Rate: 133 gpm (503 lpm)</p> <p>Suction/Discharge Size: 1.5" FNPT/FBSPT</p> <p>Max Particle Size: 0.32" (8.2 mm)</p> <p>Max Outlet Pressure: 120 psig (8.3 bar)</p> <p>Displacement Per Stroke: 0.24 gal (0.91 liter)</p>

FT15ZS Dimensional Drawing

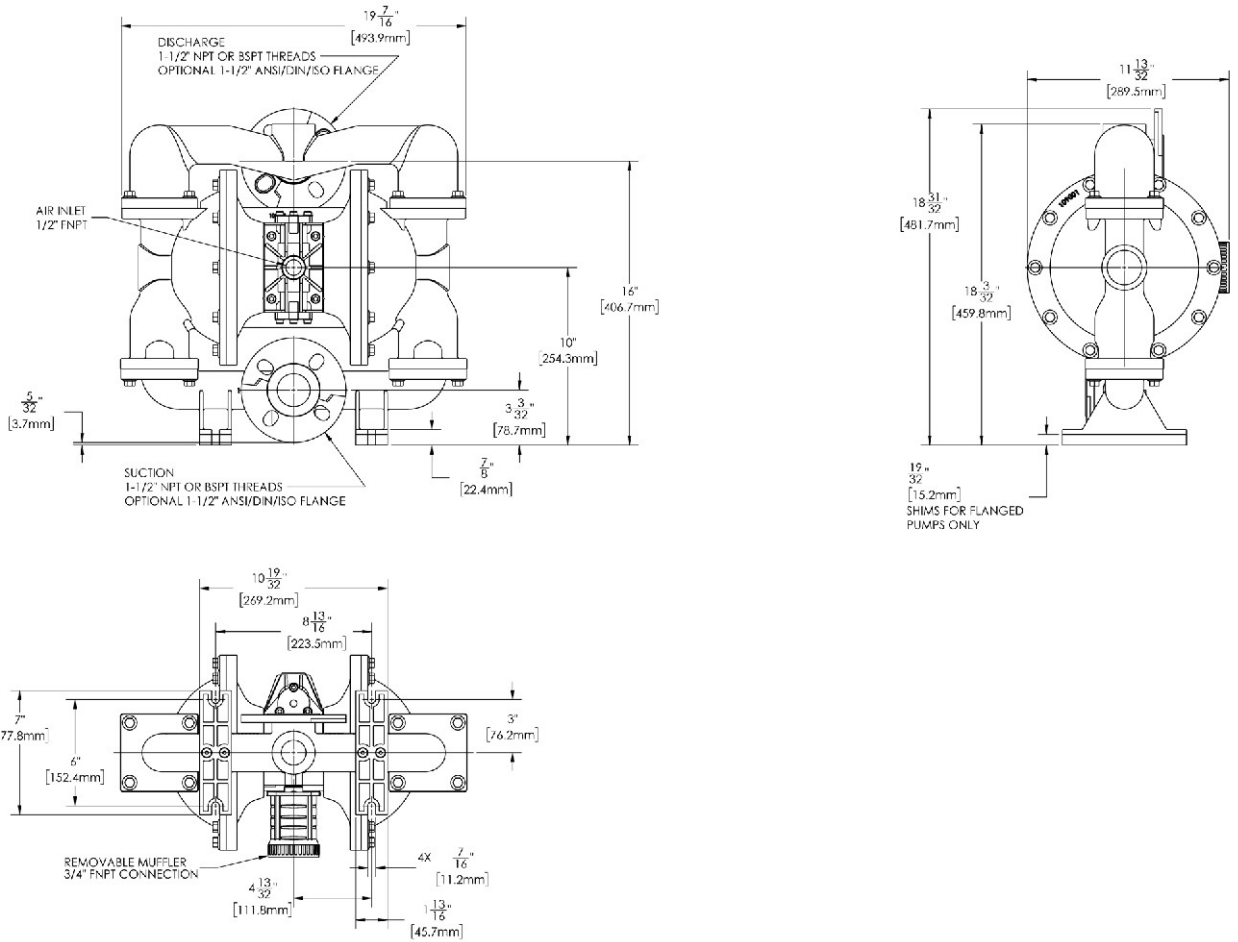

Model Number Explanation & Example Part Numbers

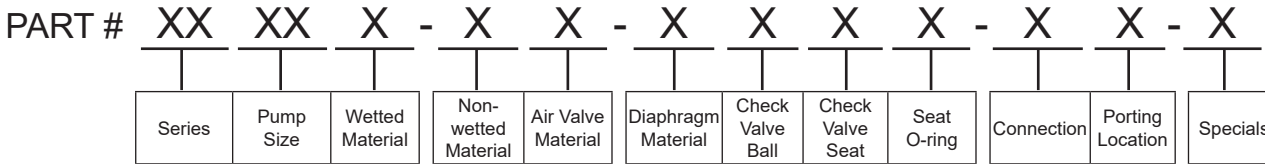

Series*

FT - Pump End
FW - Wet End

Pump Size*

15Z - 1.5"

Wetted Materials*

A - Aluminum
S - 316SS, FDA

Non-wetted Materials

P - GFRPP A - Aluminum**

Air Valve Materials

P - GFRPP A - Aluminum**
P - GFRPP A - Aluminum
w/ sensor w/ sensor

Diaphragm Materials*

N - Neoprene 1 - PTFE/Neoprene
B - Buna-N, FDA 2 - PTFE/Santoprene
E - EPDM 3 - PTFE/Buna-N, FDA
F - FKM 4 - PTFE/Santoprene, FDA
R - Santoprene 5 - Santoprene, FDA
U - Polyurethane 6 - Hytrel, FDA
H - Hytrel

Check Valve Ball Materials*

N - Neoprene F - FKM
B - Buna-N T - PTFE, FDA
E - EPDM W - Weighted PTFE, FDA
S - 316SS, FDA 5 - Santoprene, FDA
R - Santoprene

Check Valve Seat Materials*

A - Aluminum S - 316SS, FDA
T - PTFE, FDA N - Neoprene
B - Buna-N E - EPDM
F - FKM R - Santoprene
H - Hytrel 5 - Santoprene, FDA
U - Polyurethane 6 - Hytrel, FDA

Check Valve Seat O-Ring Materials*

N - Neoprene F - FKM
B - Buna-N E - EPDM
C - FEP/FKM, FDA U - Polyurethane
T - PTFE, FDA R - Santoprene
0 - None (Rubber/TPE seats)

Connection

N - FNPT B - BSPT
F - ANSI/DIN Flange T - 2" Tri-clamp

Porting location

2 - Center horizontal 3 - Center vertical
4 - Center vertical suction & end discharge

Specials

A - ATEX M1 - Metal muffler
P1 - Halogenated hydrocarbon compatible M2 - Oversized metal muffler

*Required for wet end

**Required for ATEX

Example Pump P/N's: FT15ZA-AA-NNAN-N1, FT15ZA-PP-BBAB-B2, FT1ZS-AA-1TST-N2, FT1ZS-PP-EESE-B1

Example Wet End P/N's: FT15ZW10A-NNAN, FW1ZA-BBAB, FW1ZS-1TST, FW1ZS-EESE

FT15ZA Dimensional Drawing

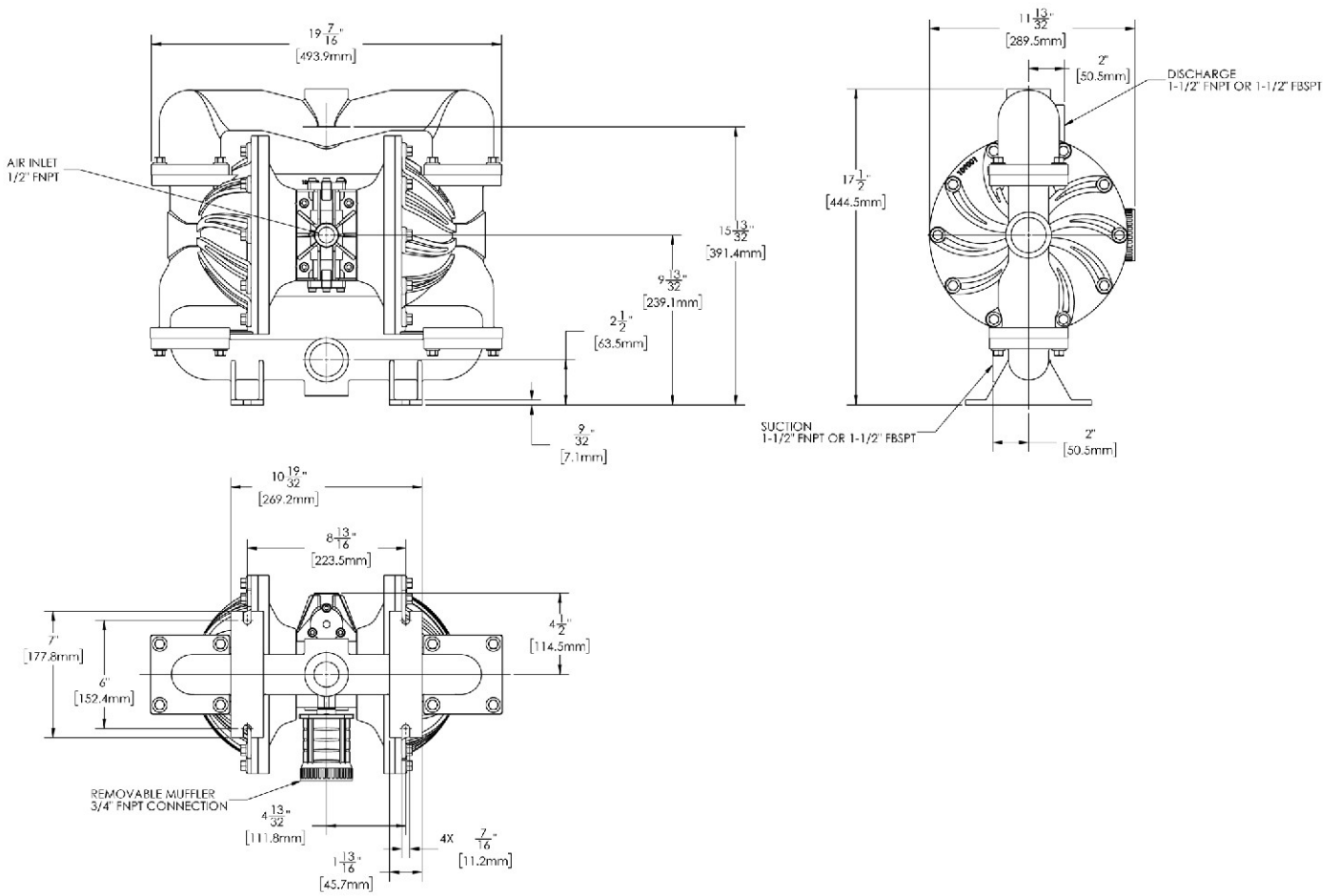

FT15ZS & FT15ZA Performance Curve

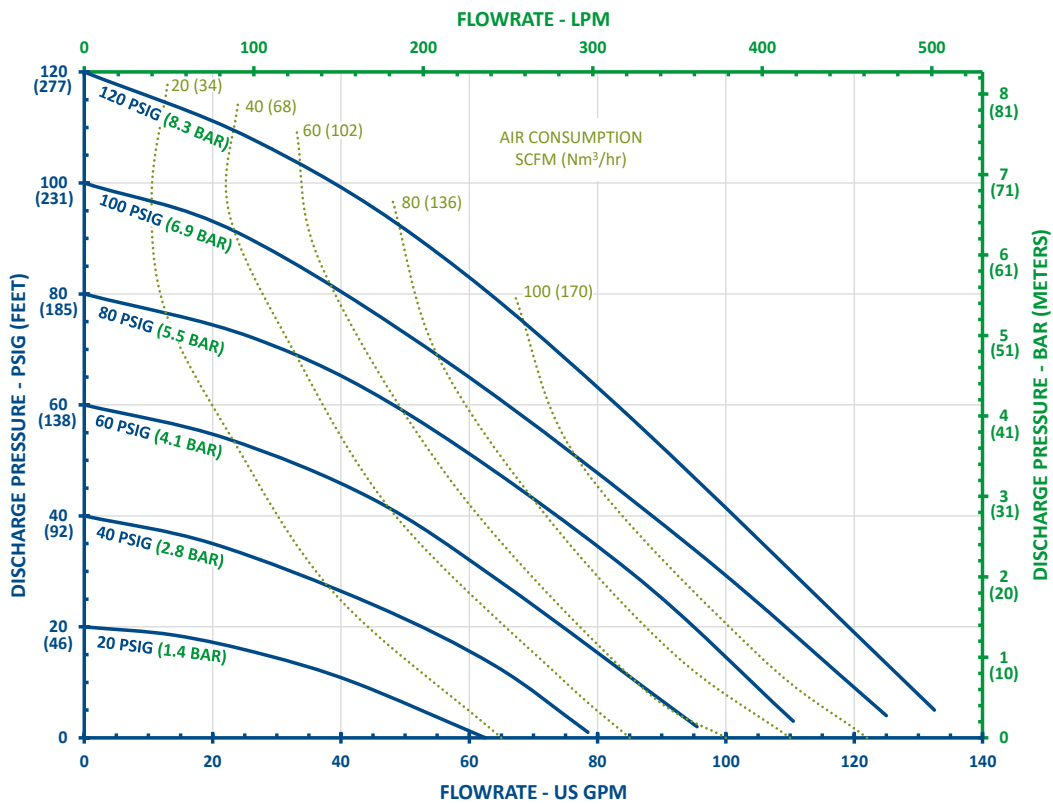

Installation Drawing

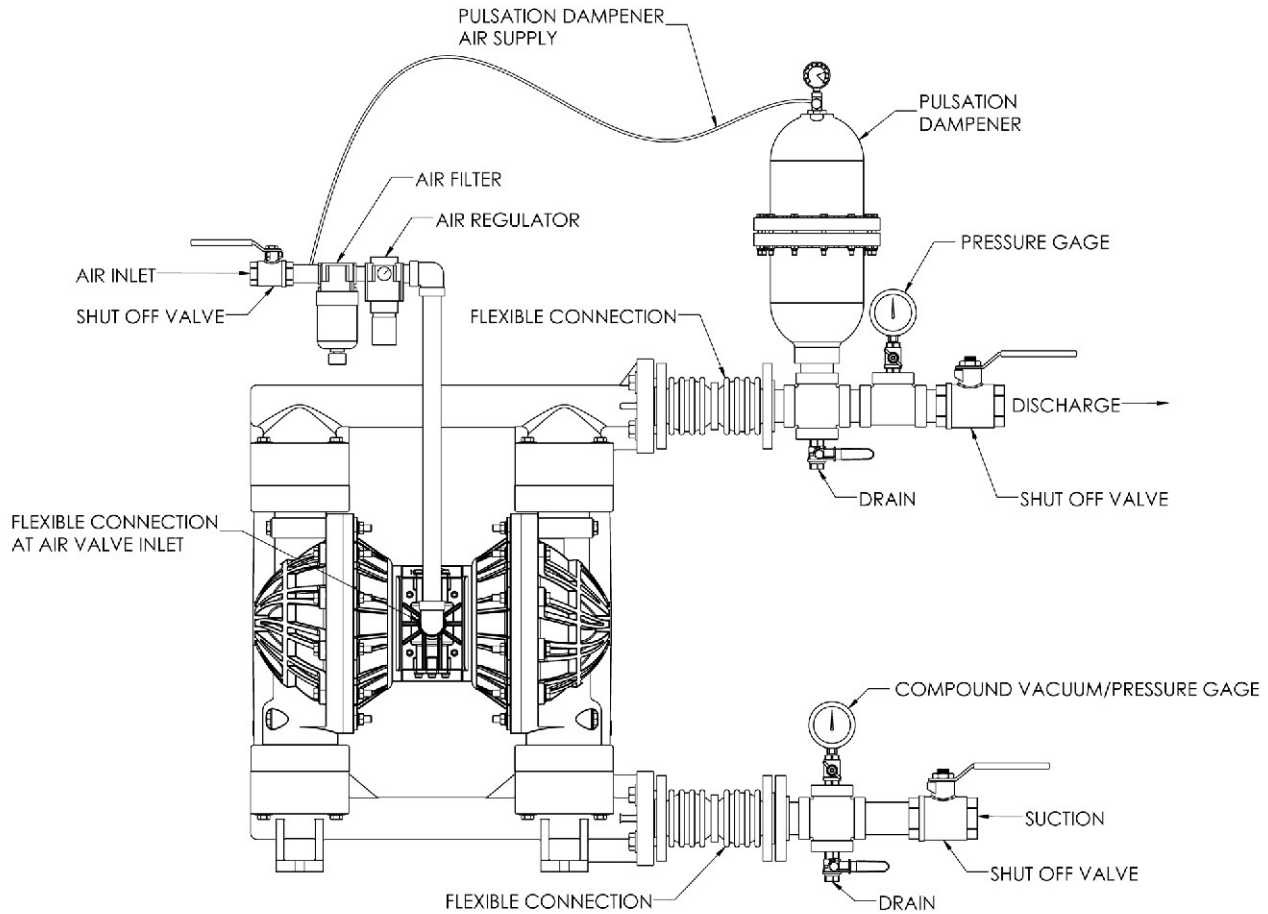

PUMP MUFFLER IS ON THE BACK SIDE OF THE PUMP.
IT CAN BE REMOVED AND EXHAUST CAN BE PIPED TO DESIRED LOCATION.

Installation / Operation Precautions

Installation and Start up

Install the pump in a vertical position or it may not prime properly. Pump should be located as close to the product being pumped as possible. Suction line length should be as short as possible and limit the number of fittings. Suction line diameter should not be reduced smaller than the suction diameter of the pump. When using rigid pipe run short sections of flexible hose or flexible connections between the pump & piping. Secure the pump to a suitable surface.

Air Supply

Connect the pump air inlet to an air supply with sufficient capacity to achieve desired performance. A pressure regulating valve should be installed to ensure air supply pressure does not exceed recommended limits.

Air Valve Lubrication

No lubrication is required for the air distribution system.

Fasteners

Re-torque all fasteners before operation. Creep of housing and gasket materials may cause fasteners to loosen. Re-torque all fasteners to the torque specifications listed on the exploded view drawing in this manual.

Air Inlet & Priming

Pump will start to operate as soon as the shut-off valve is opened. It is recommended to open the shut-off valve slowly at first. Once the pump primes; the shut-off valve can be opened additionally to increase the pump's flow. If the pump is operating but not pumping any liquid see the troubleshooting section for tips & suggestions.

Accessories

Surge suppressors, spill stops & filter regulators are available and should be used with FTI Air pumps.

Troubleshooting Tips & Suggestions

PUMP WILL NOT START OR CYCLE:

- Blocked liquid pipe or hose - Clean out or replace
- Clogged liquid chamber - Remove debris
- Diaphragm shaft bushing / o-ring leak - Replace o-rings
- Air valve carrier not shifting - Inspect, clean, re-oil with 10 wt. air tool oil. (aluminum air valve)
- Air valve carrier not shifting - Inspect, replace seals (polypropylene air valve)

ERRATIC CYCLING:

- Diaphragm failure - Replace diaphragm
- Valve ball not seating properly, worn or damaged – Inspect, remove debris or replace
- Leak in suction line - Inspect, repair or replace
- Diaphragm shaft bushing / o-ring leak - Replace o-rings
- Air valve carrier not shifting - Inspect, clean, re-oil with 10 wt. air tool oil. (aluminum air valve)
- Air valve carrier not shifting - Inspect, replace seals (polypropylene air valve)
- Over lubrication in air valve - Inspect, degrease, reuse. Adjust lubrication
- Excess moisture in air valve – Inspect, dry, reuse. Consider installing an air dryer
- For aluminum air valves, worn carrier or valve bore – measure carrier and valve bore, diametrical clearance should be between .0020” - .0035”. Replace worn components as needed
- For plastic air valves, worn carrier seals – replace carrier seals if there is no longer interference between seals and valve bore

PUMP CYCLES BUT WILL NOT PUMP:

- Too much suction lift - Reduce suction lift or fill chambers with liquid
- Leak in suction line - Inspect, repair or replace
- Valve ball not seating properly, worn or damaged - Inspect, remove debris or replace
- Clogged suction pipe or hose - Inspect & clear
- Clogged strainer if used - Inspect & clear
- Diaphragm failure - Replace diaphragm

PUMPED LIQUID RELEASED FROM AIR EXHAUST

- Diaphragm failure - Replace diaphragm
- Outer plate unthreading - Tighten & re-torque

Maintenance

Recommended Tools for Servicing Pump

- 15 mm box wrench, (2) 30 mm socket wrenches, snap ring pliers; 4 mm hex wrenches, o-ring pick, & torque wrench.

Wet End Servicing (Installing Wet End Kit)

- Relieve airline pressure and fluid line pressures before conducting maintenance.
- The pump can be drained by turning it upside down and allowing fluid to drain into an appropriate container. Use proper safety equipment when conducting maintenance as internal components may still contain the pumped media.
- Lubricate all stainless steel fasteners to prevent galling. Torque values listed in the back of this manual are for lubricated fasteners.

Wet End Disassembly

1 Remove the (8) discharge manifold bolts (item 12) from the discharge manifold (item 32) using a 15 mm (or ½") wrench.

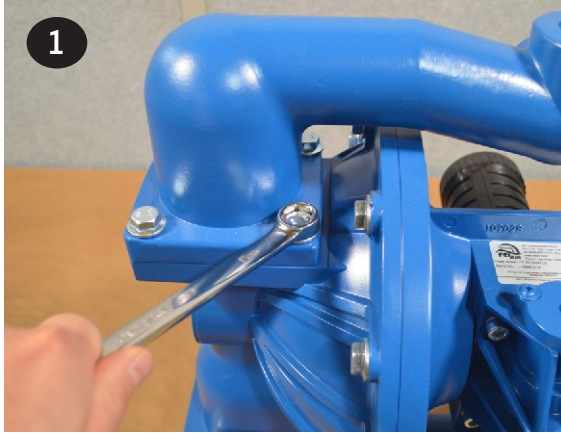

2 The discharge seat o-rings, valve seats and valve balls (items 14, 15, & 16) can now be accessed and replaced if needed.

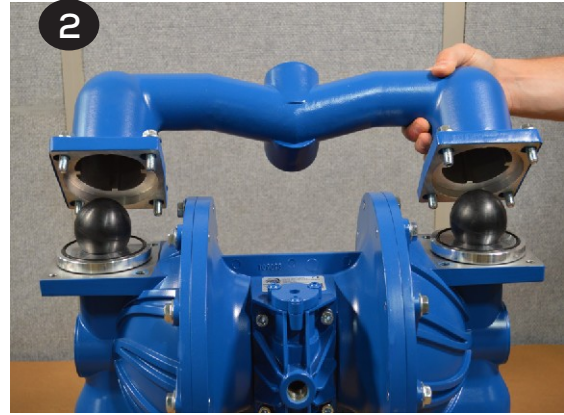

3 Repeat the above steps for the suction manifold (item 13). The seat o-rings, valve seats and valve balls (items 14, 15, & 16) are located in the liquid chambers (item 18).

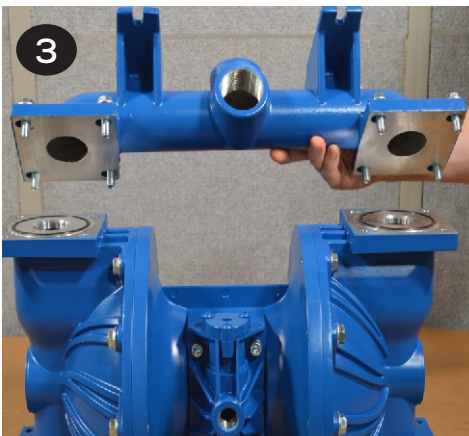

4 Remove both liquid chambers (item 18) by removing the (10) bolts (item 17) on each liquid chamber using a 15 mm wrench. Inspect and replace diaphragms if needed.



5 To remove the diaphragms (items 20/ 21), begin by loosening the (2) outer plates (item 19) using 2-30mm wrenches. Use 6-sided sockets or wrenches to prevent damage to the hex portion of the outer plate.



6 Remove the outer plate, diaphragm(s), inner plate, bump stop (items 19, 20/21, 22 & 44) from the side that is loosened. Pull or push the shaft (item 29) and remaining plates and diaphragms out of the center section. If pulling, it may be easier to grip the diaphragm if it is inverted.

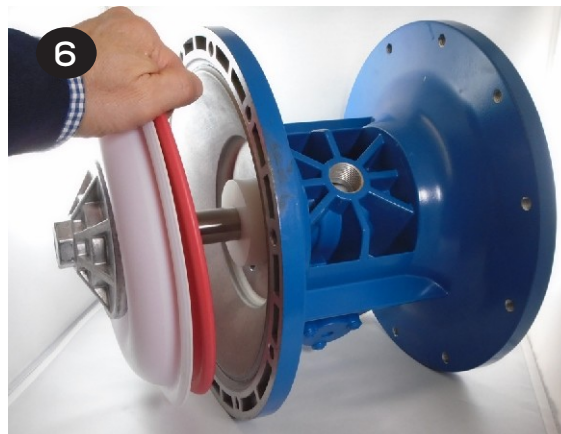

7 To remove the remaining diaphragm(s) (items 20/21) and plates (items 19 & 22) from the shaft (item 29), place the shaft in a vise fitted with soft jaws. Using a 6-sided 30mm wrench, remove the remaining diaphragm(s) and plates. Soft jaws are required to prevent damaging the shaft. A damaged shaft will result in accelerated o-ring wear. Jaws can be fitted with wood, plastic, rubber, or other soft material to prevent shaft damage.



After performing required maintenance, the pump can be reassembled. The pump can also be reassembled using the disassembly instructions in the reverse order as listed above. For detailed assembly instructions, follow the steps in the Wet End Reassembly section beginning on page 14.

Wet End Reassembly

1 Slide the center hole of one diaphragm (item 21) over the cast/threaded bolt of an outer plate (item 19). The air side of the diaphragm is labeled and should face away from the outer plate.

If the pump is fitted with PTFE diaphragms (item 20), first place a PTFE diaphragm over the cast/threaded bolt of the outer plate (item 19). Then place the backup diaphragm (item 21) on the outer plate. The shape of the PTFE diaphragm and back up diaphragm should roughly conform to one another. See the exploded view drawing for proper orientation.



2 Place the inner plate (item 22) over the cast/threaded bolt. Ensure the round recess in the plate faces the diaphragm (item 21).

Note: Diaphragms in this image are inverted for ease of assembly in step 6.

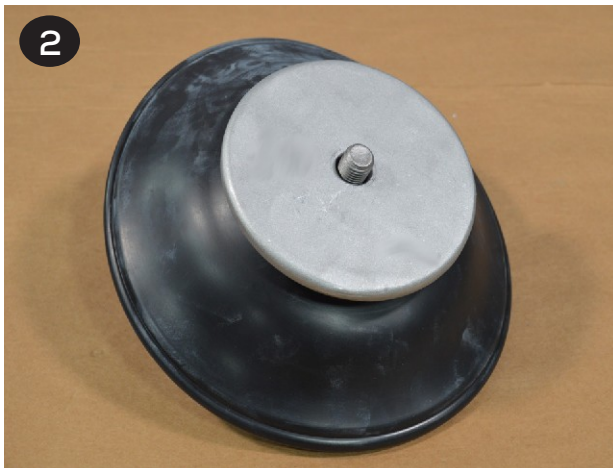

3 Apply a couple drops of a medium strength thread locker, such as Loctite® 246, to the cast/threaded outer plate bolt (item 19). Thread the shaft (item 29) onto the bolt until it is snug to the flat back side of the inner plate (item 22).



4 The shaft (item 29) and shaft o-rings (item 25) should retain the lubricant that was factory applied. If they appear dry, apply a light coat of lithium thickened grease. Avoid over lubrication as it can cause decreased performance of the air distribution system.



5 Push the shaft (item 29) through the bump stop (item 44) and center of the shaft bushing (item 24). It is normal for this to be a tight fit, especially if the shaft and shaft o-rings (item 25) are in good condition.

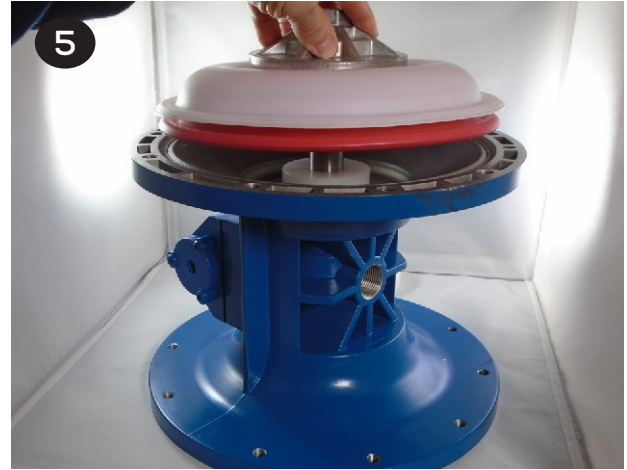

6 The other diaphragm(s) (items 20/21) inner/outer plates (items 19 & 22) and bump stop (item 44) can be installed onto the opposite end of the shaft (item 29). It may be easier to thread the bolt into the shaft if the diaphragm(s) is inverted on one or both sides. This can be done by hand.



7 Tighten and torque the outer plates (item 19) to 81.4 N-m (720 in-lbs).



8 Install the liquid chambers (item 18) by placing one side over the diaphragm. Start all bolts (item 17) before tightening and torquing. Torque all fasteners in a star pattern to 35.2 N-m (312 in-lbs). Repeat to install the second liquid chamber. Ensure both chambers are oriented in the same direction and that the inlet and outlet ports are vertical when facing the front of the pump as shown.

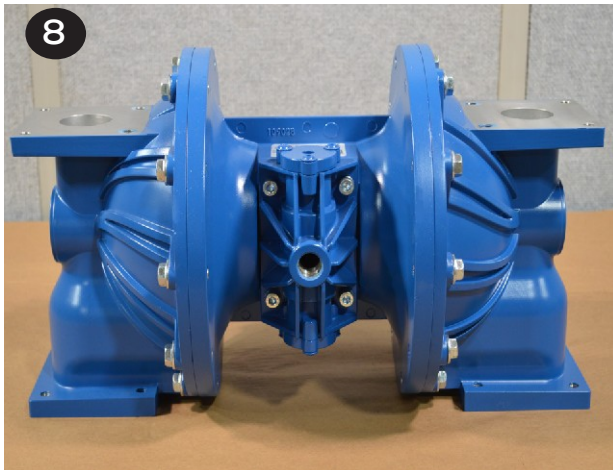

9 Flip the pump upside down and drop the suction valve balls (item 16) into the liquid chamber (item 18) ball cages.



10 Install the valve seat o-rings (item 14) into both sides of the valve seat (item 15). Install the valve seats into the liquid chambers. Valve seats are symmetrical.

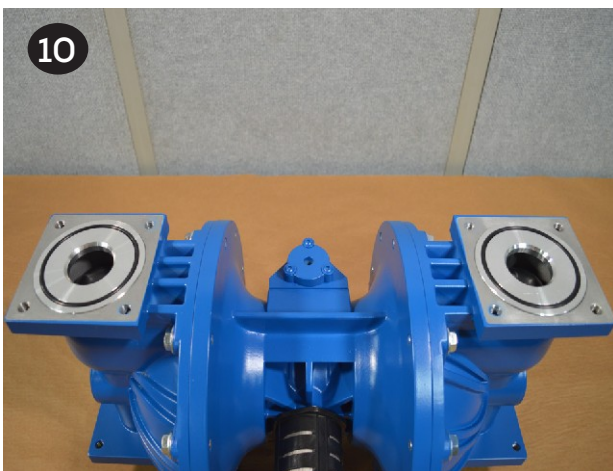

11 Place the suction manifold atop the pump. Install, tighten, and torque the (8) manifold bolts (item 12) to 35.2 N-m (312 in-lbs).

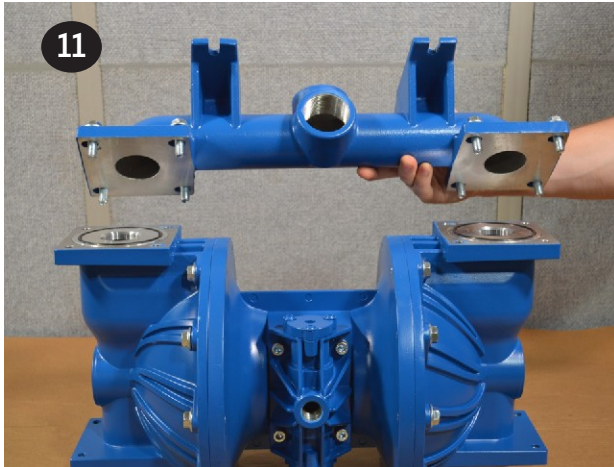

12 Stand the pump upright onto the suction manifold feet (item 13). Install the valve seat o-rings (item 14) into both sides of the valve seats (item 15). Place the valve seats on top of the liquid chambers (item 18), followed by the valve balls (item 16) on top of the valve seats. The valve seats are symmetrical. Place the manifold atop the pump, over the components that are stacked on top of the liquid chambers. Install, tighten and torque the manifold bolts (item 12) to 35.2 N-m (312 in-lbs).

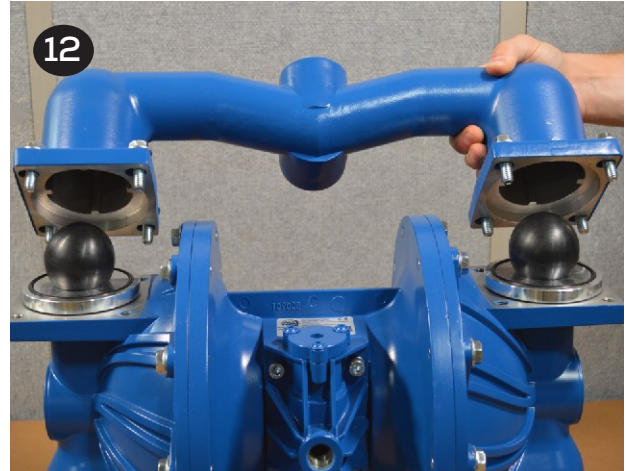

Air End Servicing (Installing Air End Kit)

- Follow steps 1 – 7 in the Wet End Servicing disassembly section to access the shaft bushing (item 24) and o-rings (items 23 & 25), then follow steps below.

Shaft, Bushing, & O-ring Replacement

1 Remove the shaft bushing retaining ring (item 26) and push the shaft bushing out of the center section.



2 Use the supplied grease packets to lightly grease the OD and ID o-rings (items 23 & 25) that come preinstalled in the new shaft bushing supplied in air end kits.

Insert the shaft bushing into the center section (item 32) and reinstall the retaining ring.



3 Inspect the shaft (item 29) for damage. It is common for shafts to become grooved during service. Grooving is normally caused by carbonized oil and/or abrasive foreign material getting trapped between the seal and the shaft. Over time, deep grooves can form in the shaft. When that occurs, it is recommended that the shaft be replaced.

- After determining if the condition of the shaft is acceptable, follow steps 5 – 12 in the Wet End Servicing – Wet End Reassembly section to rebuild the rest of the pump.



Air Valve O-Ring Replacement

1 **Plastic Air Valve** - To replace the valve cap o-rings remove the retaining ring (item 11), then pull the valve cap (item 9) straight up. The use of an M8 bolt, vise grip, and pry bar may be necessary. See 1 and 1A pictures below.



1 **Aluminum Air Valve** - To replace the valve cap o-rings (item 8), remove the (3) button head cap screws (item 10) using a 4 mm hex wrench.

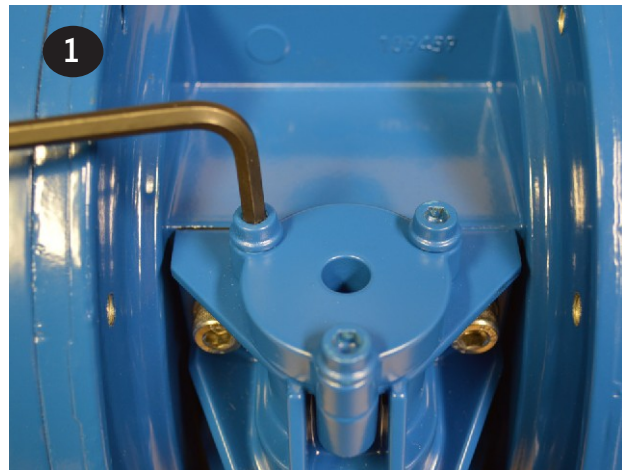

2 Plastic Air Valve - Remove and replace o-ring (item 8). Insert cap (item 9) and push down until groove for the retaining ring is visible. Install retaining ring. Make sure to lubricate the o-rings prior to inserting into the valve body with a compatible lubricant.



2 Aluminum Air Valve - Remove and replace o-ring (item 8). Install cap (item 9), tighten, and torque the valve cap screws (item 10). Repeat for the remaining cap.

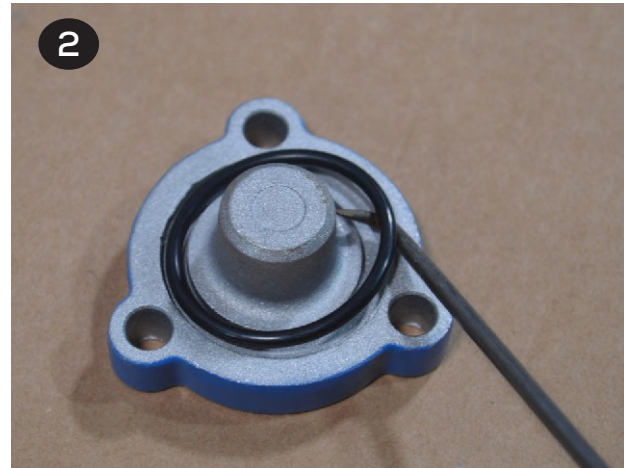

Valve Gasket Replacement

1 Remove the valve body (item 3) by removing the (4) socket head cap screws (item 1) that attach the valve body to the center section (item 31) with a 6mm hex wrench



2 Pull the valve body off the front of the center section (item 31).

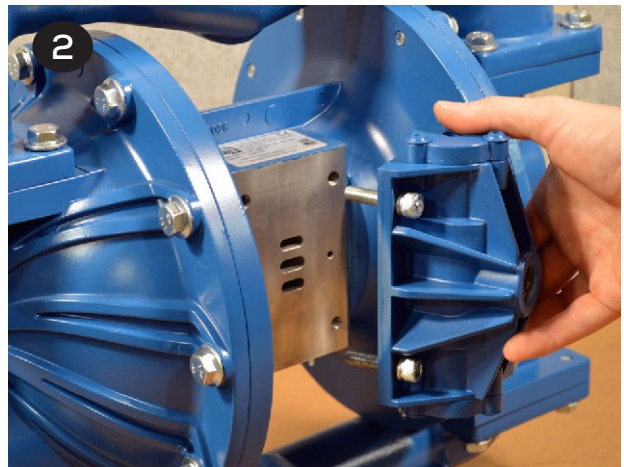

3 Place the new gasket (item 6) on the air valve (item 3) and ensure the slots in the gasket align with the slots in the air valve and valve plate (item 5).

Air Valve Slide, Plate & Gasket Orientation: If the valve plate (item 5) and slide valve (item 4) are removed, ensure they are installed in the proper orientation. The flat face of the slide valve sits in the pocket of the valve carrier (item 7) so that the square cut out on the slide valve faces the smooth polished side of the valve plate

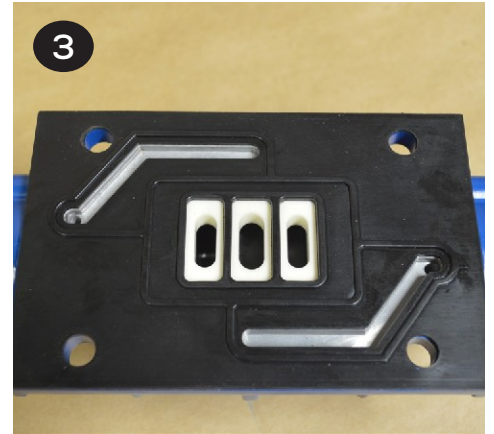
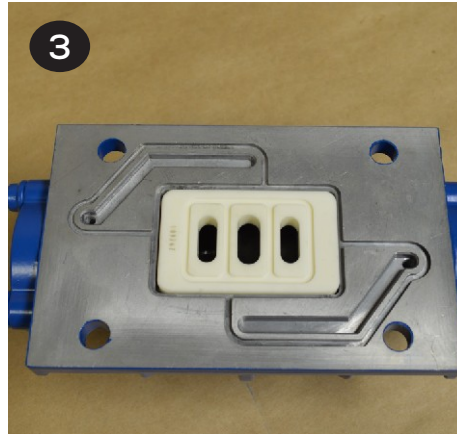
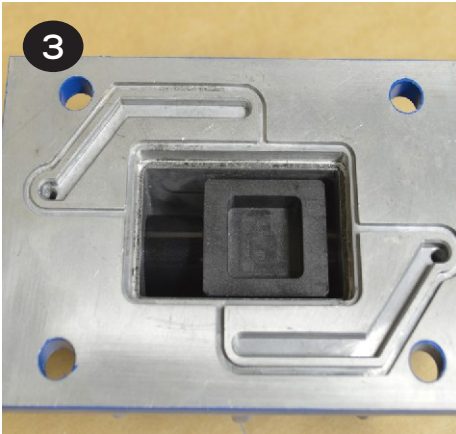

4 Insert the (4) cap screws & washers (items 1 & 2) through the valve body and gasket (items 3 & 6) and bolt to the center section (item 31). Ensure the slide valve and valve plate (items 4 & 5) are in place and the valve sits flat on the center section.

5 Tighten and torque the (4) cap screws into the muffler plate to 7.9 N-m (70 in-lbs).

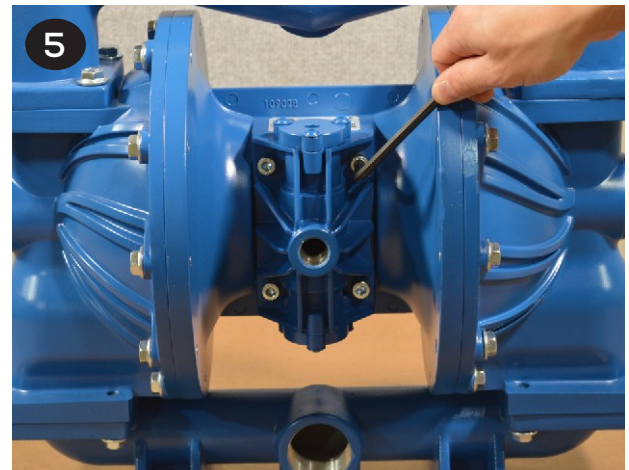
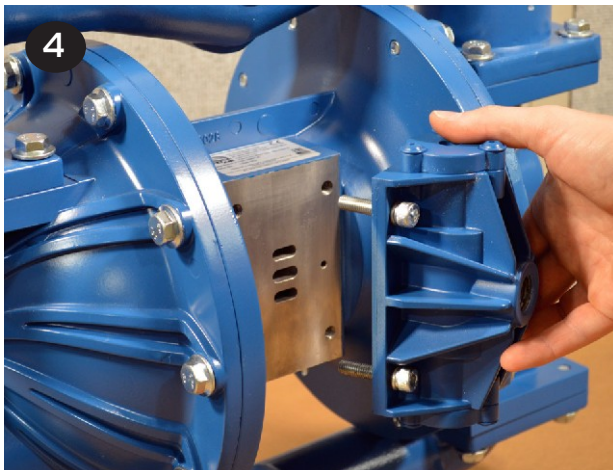

Replacement Air Valve Kit Installation

1. Remove the valve that is to be replaced by removing the (4) socket head cap screws with a 6 mm hex wrench that attaches the valve body to the center section.
 2. Save the (4) cap screws, (4) lock washers, muffler plate, and muffler. All other valve components can be discarded.
 3. Remove the packing tape that holds the air valve components in place during shipping.
- Follow steps 3 – 6 in the Valve Gasket Replacement section of Air End Servicing above.

Exploded View & Spare Parts List

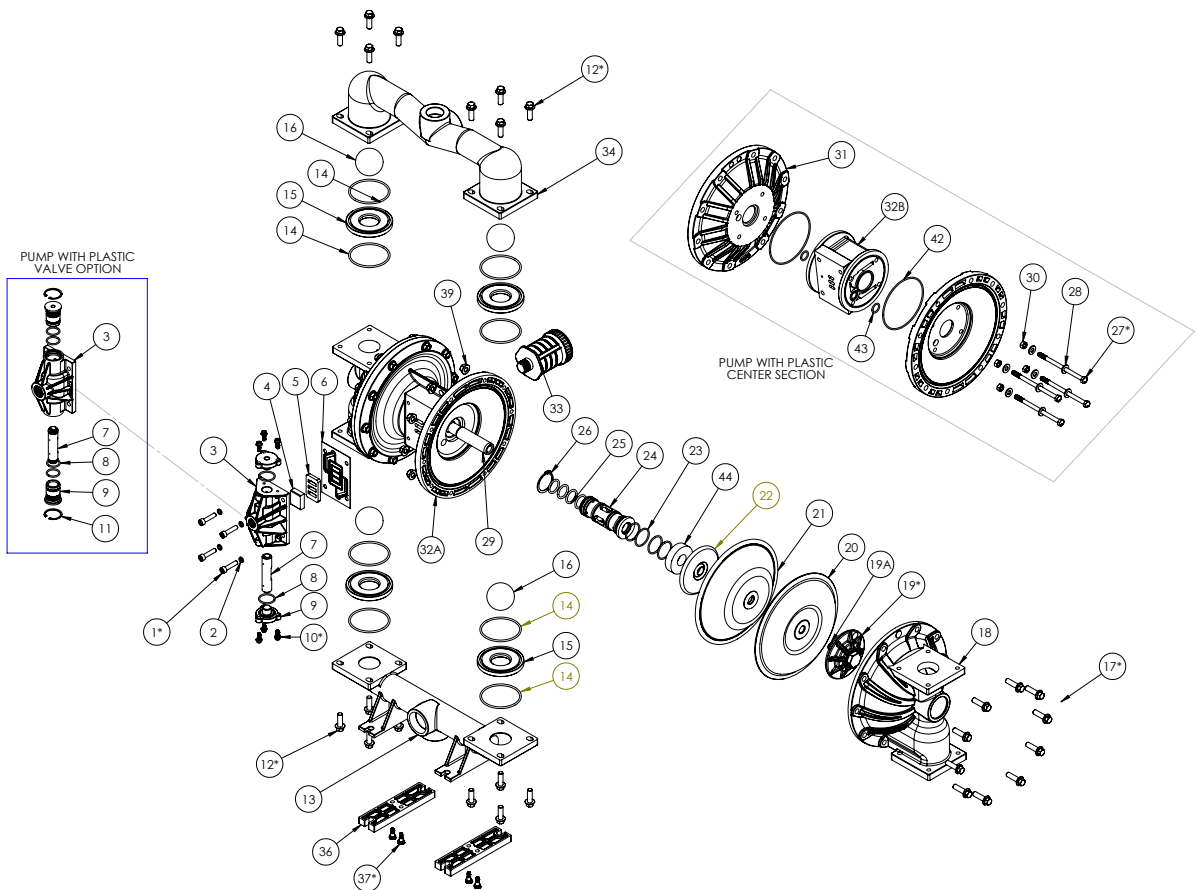

ITEM	DESCRIPTION	PART NO.	QTY	KIT
1	CAP SCREW, VALVE BODY	VARIES BY WETTED & NON-WETTED MATERIALS		
2	WASHER, VALVE BODY	VARIES BY WETTED & NON-WETTED MATERIALS		
3	VALVE BODY	SEE AIR VALVE TABLES		
4	SLIDE VALVE	109843	1	V1/V2
5	VALVE PLATE	109845	1	V1/V2
6	GASKET, AIR VALVE	109266	1	V1/V2
7	VALVE CARRIER	SEE AIR VALVE TABLES		
8	O-RING, VALVE CAP	SEE AIR VALVE TABLES		

ITEM	DESCRIPTION	PART NO.	QTY	KIT
9	VALVE CAP	SEE AIR VALVE TABLES		
10	CAP SCREW, VALVE CAP	SEE AIR VALVE TABLES		
11	RETAINING RING, VALVE CAP	SEE AIR VALVE TABLES		
12	CAP SCREW, MANIFOLD	VARIES BY WETTED & NON-WETTED MATERIALS		
13	MANIFOLD, SUCTION	SEE MANIFOLD TABLES		
14	O-RING, VALVE SEAT, NEOPRENE	109036	8	W
	O-RING, VALVE SEAT, BUNA	109308		
	O-RING, VALVE SEAT, EPDM	109037		
	O-RING, VALVE SEAT, PTFE	109038		
	O-RING, VALVE SEAT, FKM	109323		
	O-RING, VALVE SEAT, FEP ENCAPSULATED FKM	109536		
	O-RING, VALVE SEAT, POLYURETHANE	109537		
	O-RING, VALVE SEAT, SANTOPRENE	109538		
15	VALVE SEAT, PTFE	109018	4	W
	VALVE SEAT, ALUMINUM	109019		
	VALVE SEAT, STAINLESS STEEL	109020		
	VALVE SEAT, NEOPRENE	109021-1		
	VALVE SEAT, BUNA	109021-2		
	VALVE SEAT, EPDM	109021-3		
	VALVE SEAT, FKM	109021-4		
	VALVE SEAT, SANTOPRENE	109022-1		
	VALVE SEAT, HYTREL	109022-2		
	VALVE SEAT, POLYURETHANE	109022-3		
	VALVE SEAT, FDA SANTOPRENE	109022-4		
	VALVE SEAT, FDA HYTREL	109022-5		
	VALVE SEAT, POLYPROPYLENE	109030		
	VALVE SEAT, PVDF	109030-1		
16	VALVE BALL, NEOPRENE	109025-1	4	W
	VALVE BALL, BUNA	109025-2		
	VALVE BALL, EPDM	109025-3		
	VALVE BALL, FKM	109025-4		
	VALVE BALL, SANTOPRENE	109026-1		
	VALVE BALL, FDA SANTOPRENE	109026-4		
	VALVE BALL, PTFE	109027		
	VALVE BALL, WEIGHTED PTFE	109031		
	VALVE BALL, 316 STAINLESS STEEL	109032		
17	CAP SCREW, LIQUID CHAMBER	VARIES BY WETTED & NON-WETTED MATERIALS		
18	LIQUID CHAMBER, ALUMINUM	109767-20	2	
	LIQUID CHAMBER, 316 STAINLESS STEEL	109767-21		
19	OUTER PLATE, ALUMINUM	109012	2	
	OUTER PLATE, 316 STAINLESS STEEL (REQUIRES ITEM 19A)	109013		
20	DIAPHRAGM, PTFE	109017	2	W

ITEM	DESCRIPTION	PART NO.	QTY	KIT
21	DIAPHRAGM, NEOPRENE	109023-1	2	W
	DIAPHRAGM, BUNA	109023-2		
	DIAPHRAGM, EPDM	109023-3		
	DIAPHRAGM, FKM	109023-4		
	DIAPHRAGM, SANTOPRENE	109023-5		
	DIAPHRAGM, HYTREL	109023-6		
	DIAPHRAGM, POLYURETHANE	109023-7		
	DIAPHRAGM, FDA SANTOPRENE	109023-8		
	DIAPHRAGM, FDA HYTREL	109023-9		
22	INNER PLATE, ALUMINUM	109169-1	2	
	INNER PLATE, STAINLESS STEEL	109716-1		
23	O-RING, BUSHING OD	109420	4	A1/A2
24	BUSHING, SHAFT, ALUMINUM CENTER SECTION w/ O-RINGS (ITEMS 23 & 25)	109070	1	
	BUSHING, SHAFT, PLASTIC CENTER SECTION w/ O-RINGS (ITEMS 23 & 25)	109069	2	
25	O-RING, SHAFT	109424	4	A1/A2
26	RING, RETAINING, SHAFT BUSHING	209024	1	A2
27	CAP SCREW, PLASTIC CENTER SECTION ONLY (OPTIONAL)	SEE HARDWARE TABLES		
28	WASHER, PLASTIC CENTER SECTION ONLY (OPTIONAL)	SEE HARDWARE TABLES		
29	SHAFT	109015	1	
30	NUT, PLASTIC CENTER SECTION ONLY	SEE HARDWARE TABLES		
31	AIR CHAMBER, GF POLYPROPYLENE (OPTIONAL)	109010	2	
32A	CENTER SECTION, ALUMINUM	109028	1	
32B	CENTER SECTION, GF POLYPROPYLENE (OPTIONAL)	109009	1	
33	MUFFLER, GF POLYPROPYLENE	109562	1	
	MUFFLER, STEEL	109700		
	MUFFLER, STEEL, LARGE	109794		
34	MANIFOLD, DISCHARGE	SEE MANIFOLD TABLES		
35	GROUND LUG (NOT SHOWN)	108091+	1	
36	SHIM, FOOT, FOR USE WITH SS FLANGE OPTION	SEE MANIFOLD TABLES		
37	SHOULDER BOLT, SHIM, FOR USE WITH SS FLANGE OPTION			
38	SPLIT FLANGE HALF, FOR USE WITH SS FLANGE OPTION (NOT SHOWN)			
39	NUT, LIQUID CHAMBER	SEE HARDWARE TABLES		
41	PLUG, PIPE 316 STAINLESS STEEL	SEE MANIFOLD TABLES		
42	O-RING, PLASTIC CENTER SECTION TO AIR CHAMBER, LARGE (OPTIONAL)	108588	2	A1
43	O-RING, PLASTIC CENTER SECTION TO AIR CHAMBER, SMALL (OPTIONAL)	109039	2	A1
44	BUMP STOP	109924	2	A1, A2

FT15ZA & FT15ZS Kits		
Kit Key	Description	Part No.
W	PARTS SUPPLIED IN WET END KITS	SEE PAGE 8
A1	PARTS SUPPLIED IN AN AIR END KIT (PLASTIC CENTER SECTION)	109055
A2	PARTS SUPPLIED IN AN AIR END KIT (ALUMINUM CENTER SECTION)	109055-1
V1	PARTS SUPPLIED IN PLASTIC REPLACEMENT AIR VALVE KIT	109051-1
V2	PARTS SUPPLIED IN AN ALUMINUM REPLACEMENT AIR VALVE KIT	109050

PUMPS FITTED WITH ALUMINUM AIR VALVES FT15Z -A- - - -				
ITEM	DESCRIPTION	PART NO.	QTY	KIT
3	VALVE BODY, ALUMINUM	SEE ITEM 40	1	
7	VALVE CARRIER, ALUMINUM	109844	1	
8	O-RING, VALVE CAP	109415	2	
9	VALVE CAP, ALUMINUM	SEE ITEM 40	2	
10	CAP SCREW, BUTTON HEAD, M6-1.0 X 16MM SSTL	109513	6	
40	CONTAINS ITEMS 3, 7, 8, 9, AND 11	109049	1	V2

PUMPS FITTED WITH GFRPP AIR VALVES FT15Z -A- - - -				
ITEM	DESCRIPTION	PART NO.	QTY	KIT
3	VALVE BODY	109903	1	V1
7	VALVE CARRIER WITH SEALS	111365	1	V1
8	O-RING, VALVE CAP	109891	4	V1
9	VALVE CAP - DELRIN	109889	2	V1
11	RETAINING RING, H0-137 SSTL	109647	2	V1

SUCTION MANIFOLD												
BEGINNING OF MODEL NUMBER	LAST 2 DIGITS OF MODEL NUMBER											
	N2 (CH)		N3 (CV)		B2 (CH)		B3 (CV)		T2 (CH)		F2 (CH)	
	PART NO.	QTY	PART NO.	QTY	PART NO.	QTY	PART NO.	QTY	PART NO.	QTY	PART NO.	QTY
FT15ZA - ITEM 13)	109004	1	109059	1	109004-1	1	109059-1	1	N/A	1	N/A	1
ITEM 41 (NOT SHOWN)	N/A	-	209031	1	N/A	-	209032	1				
FT15ZS - ITEM 13)	109005	1	109059-2	1	109005-1	1	109059-3	1	109005-10	1	109005	1
ITEM 41 (NOT SHOWN)	N/A	-	209031	1	N/A	-	209032	1	N/A	-	N/A	-
ITEM 36	N/A	-	N/A	-	N/A	-	N/A	-	N/A	-	109033	2
ITEM 37	N/A	-	N/A	-	N/A	-	N/A	-	N/A	-	209030	4
ITEM 38	N/A	-	N/A	-	N/A	-	N/A	-	N/A	-	109578-1	2

DISCHARGE MANIFOLD												
BEGINNING OF MODEL NUMBER	LAST 2 DIGITS OF MODEL NUMBER											
	N2 (CH)		N3 (CV)		B2 (CH)		B3 (CV)		T2 (CH)		F2 (CH)	
	PART NO.	QTY	PART NO.	QTY	PART NO.	QTY	PART NO.	QTY	PART NO.	QTY	PART NO.	QTY
FT15ZA - ITEM 34)	109007	1	109058	1	109007-1	1	109058-1	1	N/A	-	N/A	-
ITEM 41 (NOT SHOWN)	N/A	-	209031	1	N/A	-	209032	1				
FT15ZS - ITEM 34)	109008	1	109058-2	1	109008-1	1	109059-3	1	109008-10	1	109008	1
ITEM 41 (NOT SHOWN)	N/A	-	209031	1	N/A	-	209032	1	N/A	-	N/A	-
ITEM 36	N/A	-	N/A	-	N/A	-	N/A	-	N/A	-	N/A	-
ITEM 38	N/A	-	N/A	-	N/A	-	N/A	-	N/A	-	109578-1	2

Optional Porting locations:
 CH = Center Horizontal
 CV = Center Vertical

MODEL FT15ZA HARDWARE

ITEM	NON-WETTED MATERIAL	DESCRIPTION	PART NO.	QTY
1	A OR P	CAP SCREW, SOCKET HEAD, M8-1.25 X 35MM	209020	4
2	A OR P	WASHER, LOCK HIGH COLLAR, M8	109493	4
12	A OR P	CAP SCREW, HEX HEAD FLANGED, M10-1.5 X 30MM	209019	16
17	A	CAP SCREW, HEX HEAD FLANGED, M10-1.5 X 30MM	209019	20
	P	CAP SCREW, HEX HEAD FLANGED, M10-1.5 X 50MM	209029	20
27	P	CAP SCREW, HEX HEAD, M8-1.25 X 130MM BLACK	209021	4
28	P	WASHER, FLAT M8 BLACK	109469	8
30	P	NUT, HEX, M8-1.25 BLACK	109474	4
39	P	NUT, HEX M10-1.5 FLANGED	109485	20

A = Aluminum Center Section P = Plastic Center Section

MODEL FT15ZS HARDWARE

ITEM	NON-WETTED MATERIAL	DESCRIPTION	PART NO.	QTY
1	A OR P	CAP SCREW, SOCKET HEAD, M8-1.25 X 35MM SSTL	105589	4
2	A OR P	WASHER, LOCK HIGH COLLAR, M8 SSTL	109518	4
12	A OR P	CAP SCREW, HEX HEAD FLANGED M10-1.5 X 30MM	109497	16
17	A	CAP SCREW, HEX HEAD FLANGED M10-1.5 X 30MM	109497	20
	P	CAP SCREW, HEX HEAD FLANGED M10-1.5 X 50MM	109498	20
19A	A	STUD, OUTER PLATE (STAINLESS STEEL ONLY)	109523	2
27	P	CAP SCREW, HEX HEAD, M8-1.25 X 130MM BLACK	209021	4
28	P	WASHER, FLAT M8 BLACK	109469	8
30	P	NUT, HEX, M8-1.25 BLACK	109474	4
39	P	NUT, HEX M10-1.5 FLANGED	109485	20

A = Aluminum Center Section P = Plastic Center Section

FT15ZA & FT15ZS MAXIMUM TORQUE SETTINGS*			
STAINLESS STEEL PUMPS		ALUMINUM PUMPS	
ITEM #	TORQUE	ITEM #	TORQUE
1	7.9 N-m (70 in-lbs)+	1	7.9 N-m (70 in-lbs)
10	6.8 N-m (60 in-lbs)	10	6.8 N-m (60 in-lbs)
12	35.2 N-m (312 in-lbs)+	12	35.2 N-m (312 in-lbs)
17	35.2 N-m (312 in-lbs)+	17	35.2 N-m (312 in-lbs)
19	81.4 N-m (720 in-lbs)+	19	81.4 N-m (720 in-lbs)+
27	16.3 N-m (144 in-lbs)	27	16.3 N-m (144 in-lbs)
37	8 N-m (72 in-lbs)+		

ASTERISK (*) FROM THE EXPLODED VIEW DIAGRAM INDICATES FASTENERS TO BE TORQUED. STAINLESS STEEL TO STAINLESS STEEL FASTENERS SHOULD BE LUBRICATED TO PREVENT GALLING. A PLUS SIGN (+) ON THE ABOVE TORQUE VALUES INDICATES A LUBRICATED FASTENER.

Warranty



FTI Air A Division of Finish Thompson, Inc (manufacturer) warrants this pump product to be free of defects in materials and workmanship for a period of **five years** from date of purchase by original purchaser. If a warranted defect, which is determined by manufacturer's inspection, occurs within this period, it will be repaired or replaced at the manufacturer's option, provided (1) the product is submitted with proof of purchase date and (2) transportation charges are prepaid to the manufacturer.

Liability under this warranty is expressly limited to repairing or replacing the product or parts thereof and is in lieu of any other warranties, either expressed or implied. This warranty does not apply to normal wear of the product or components. This warranty does not apply to products or parts broken due to, in whole or in part, accident, overload, abuse, chemical attack, tampering, or alteration. The warranty does not apply to any other equipment used or purchased in combination with this product. The manufacturer accepts no responsibility for product damage or personal injuries sustained when the product is modified in any way. If this warranty does not apply, the purchaser shall bear all cost for labor, material and transportation.

Manufacturer shall not be liable for incidental or consequential damages including, but not limited to process down time, transportation costs, costs associated with replacement or substitution products, labor costs, product installation or removal costs, or loss of profit. In any and all events, manufacturer's liability shall not exceed the purchase price of the product and/or accessories



FINISH THOMPSON INC. - HEADQUARTERS

921 Greengarden Road | Erie, PA 16501
800.934.9384 | ph 814.455.4478 | fx 814.455.8518
email fti@finishthompson.com

FINISH THOMPSON GMBH - EUROPE CENTER

Otto-Hahn-Strasse 16 | Maintal, D-63477 Germany
49 (0)6181-90878-0 | fx 49 (0)6181-90878-18
email europecenter@finishthompson.com