

EOM

ENGINEERING OPERATION
& MAINTENANCE MANUAL

P200 Bolted Plastic Pump

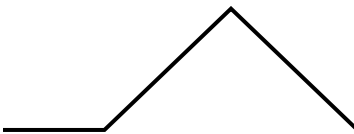

Where Innovation Flows

WILDEN®



Copyright

Copyright 2018 PSG®, a Dover Company. All rights reserved.

PSG reserves the right to modify the information and illustrations in this document without prior notice. The product described in this document is furnished under a license agreement or nondisclosure agreement. No part of this document may be reproduced, stored in a retrieval system, or transmitted in any form or any means electronic or mechanical, including photocopying and recording, without the written permission of PSG, a Dover Company, except as described by the terms of those agreements.

This is a non-contractual document.

Trademarks

PSG and the PSG logo are registered trademarks of PSG. Wilden® is a registered trademark of PSG California LLC. Pro-Flo® SHIFT and Pro-Flo® are registered trademarks of PSG California LLC. Wil-Flex® is a trademark of PSG California LLC. Saniflex™ is a trademark of PSG California LLC.

All trademarks, names, logos and service marks (collectively “trademarks”) in this document are registered and unregistered trademarks of their respective owners. Nothing contained in this document should be construed as granting any license or right to use any trademark without the prior written permission of the trademark owner.

Warranty

Each and every product manufactured by Wilden is built to meet the highest standards of quality. Every pump is functionally tested to ensure integrity of operation. Wilden warrants that pumps, accessories and parts manufactured or supplied by it to be free from defects in material and workmanship for a period of five (5) years from date of installation or six (6) years from date of manufacture, whichever comes first.

For more information, and to register your Wilden pump for warranty, please visit <https://www.psgdover.com/wilden/support/warranty-registration>.

Certifications





CONTENTS

SECTION 1: Precautions – Read First!	4
SECTION 2: Wilden Pump Designation System	5
SECTION 3: How It Works	6
SECTION 4: Dimensional Drawings	7
SECTION 5: Performance	9
P200 Plastic Rubber-Fitted	9
P200 Plastic TPE-Fitted	9
P200 Plastic Reduced-Stroke PTFE-Fitted	10
P200 Plastic Full-Stroke PTFE-Fitted	10
Suction Lift Capability	11
SECTION 6: Suggested Installation, Operation, Maintenance, and Troubleshooting	12
SECTION 7: Disassembly/Reassembly	15
Pump Disassembly	15
Air Valve Disassembly	19
Reassembly Hints and Tips	22
Shaft Seal Installation	23
SECTION 8: Exploded View and Parts List	24
SECTION 9: Elastomer Options	26

SECTION 1

PRECAUTIONS – READ FIRST!

 **WARNING:** Always wear safety glasses when operating a pump to avoid eye injury. If diaphragm rupture occurs, material being pumped may be forced out of the air exhaust.

 **CAUTION:** Do not apply compressed air to the exhaust port – pump will not function.

 **CAUTION:** Do not over-lubricate air supply– excess lubrication will reduce pump performance. Pump is pre-lubed.

 **TEMPERATURE LIMITS:**

Acetal	-29°C to 82°C	-20°F to 180°F
Buna-N	-12°C to 82°C	10°F to 180°F
Geolast®	-40°C to 82°C	-40°F to 180°F
Neoprene	-18°C to 93°C	0°F to 200°F
Nordel EPDM	-51°C to 138°C	-60°F to 280°F
Nylon	-18°C to 93°C	0°F to 200°F
PFA	-7°C to 107°C	45°F to 225°F
Polypropylene	0°C to 79°C	32°F to 175°F
Polyurethane	-12°C to 66°C	10°F to 150°F
PVDF	-12°C to 107°C	10°F to 225°F
Saniflex	-29°C to 104°C	-20°F to 220°F
SIPD PTFE with EPDM-backed	4°C to 137°C	40°F to 280°F
SIPD PTFE with Neoprene-backed	4°C to 93°C	40°F to 200°F
PTFE*	4°C to 104°C	40°F to 220°F
FKM	-40°C to 177°C	-40°F to 350°F
Wil-Flex	-40°C to 107°C	-40°F to 225°F

*4°C to 149°C (40°F to 300°F) - 13 mm (1/2") and 25 mm (1") models only.

NOTE: Not all materials are available for all models. See "Wilden Pump Designation System" material options for your pump.

 **CAUTION:** When choosing pump materials, be sure to check the temperature limits for all wetted components. Example: FKM has a maximum limit of 177°C (350°F), but polypropylene has a maximum limit of only 79°C (175°F).

 **CAUTION:** Maximum temperature limits are based on mechanical stress only. Certain chemicals will reduce maximum safe operating temperatures significantly. Consult the Chemical Resistance Guide for chemical compatibility and temperature limits.

 **CAUTION:** All Wilden pumps are capable of passing solids. Use a strainer on the pump intake to ensure that the pump's rated solids capacity is not exceeded.

 **CAUTION:** Do not exceed 8.6 bar (125 psig) air supply pressure.

 **CAUTION:** Do not exceed 82°C (180°F) air inlet temperature for all models.

 **CAUTION:** The process fluid and cleaning fluids must be compatible chemically with all wetted pump components.

 **CAUTION:** Thoroughly flush pumps before installing them into process lines. Clean and/or sanitize FDA- and USDA- approved pumps before using them.

 **CAUTION:** Before attempting any maintenance or repair, disconnect the compressed air line to the pump and allow all air pressure to bleed from the pump. Disconnect all intake, discharge, and air lines. Drain the pump by turning it upside down and allowing any fluid to flow into a suitable container. Be aware of any hazardous effects of contact with your process fluid.

 **CAUTION:** Before attaching the air line to the pump, blow out the air line for 10 to 20 seconds to make sure all pipeline debris is clear. Use an in-line air filter. A 5µ (micron) air filter is recommended.

 **CAUTION:** Pro-Flo pumps cannot be used in submersible applications.

 **CAUTION:** Before installation, tighten all hardware.

 **NOTE:** Materials of construction and elastomer material may influence suction lift parameters. Please refer to "Performance " for specifics.

 **NOTE:** When installing PTFE diaphragms, it is important to tighten outer pistons simultaneously (turning in opposite directions) to ensure tight fit. (See "Maximum Torque Specifications").

 **NOTE:** Some PTFE-fitted pumps come standard from the factory with expanded PTFE gaskets installed in the diaphragm bead of the liquid chamber. PTFE gaskets cannot be re-used.

 **NOTE:** In the event of a power failure, close the shut-off valve if you do not want the pump to restart when the power returns.

 **WARNING:** This product can expose you to chemicals including Nickel, Chromium, Cadmium, or Cobalt, which are known to the State of California to cause cancer and/or birth defects or other reproductive harm. For more information, go to www.P65Warnings.ca.gov.

SECTION 2

WILDEN PUMP DESIGNATION SYSTEM

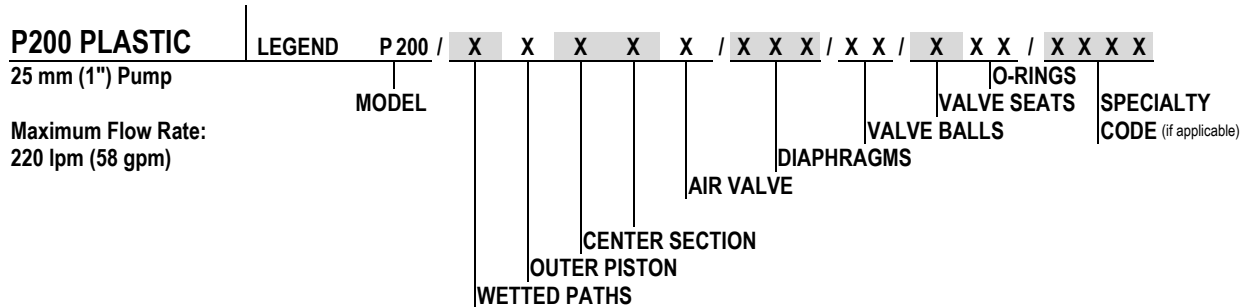

MATERIAL CODES

MODEL	DIAPHRAGMS	VALVE BALLS
P200 = PRO-FLO® PLASTIC	BNS = BUNA-N (RED DOT)	BN = BUNA-N (RED DOT)
	EPS = EPDM (BLUE DOT)	FS = SANIFLEX™ [HYTREL® (CREAM)]
WETTED PATH	FSL = FULL-STROKE SANIFLEX™	EP = EPDM (BLUE DOT)
K = PVDF	ISD [HYTREL® (CREAM)]	NE = NEOPRENE (GREEN DOT)
P = POLYPROPYLENE	FSS = SANIFLEX™ [HYTREL® (CREAM)]	TF = PTFE (WHITE)
OUTER PISTON	FWL = FULL-STROKE SANITARY	VT = FKM (SILVER OR WHITE DOT)
K = PVDF	WIL-FLEX™, IPD	WF = WIL-FLEX™ [SANTOPRENE® (THREE BLACK DOTS)]
Z = NO OUTER PISTON	[SANTOPRENE® (THREE BLACK DOTS)]	
CENTER SECTION	FWS = SANITARY WIL-FLEX™, [SANTOPRENE® (TWO BLACK DOTS)]	VALVE SEATS
PP = POLYPROPYLENE	LEL = PTFE W/EPDM BACKED, IPD (TWO BLACK DOTS)	K = PVDF
AIR VALVE	NES = NEOPRENE (GREEN DOT)	P = POLYPROPYLENE
P = POLYPROPYLENE	SSL = FULL-STROKE SANIFLEX™ IPD [HYTREL® (CREAM)]	
	TEU = PTFE W/EPDM BACKUP (WHITE)	VALVE SEATS & MANIFOLD O-RING
	TNU = PTFE W/NEOPRENE BACKUP (WHITE)	BN = BUNA-N
	TSS = FULL-STROKE PTFE W/SANIFLEX™ BACK-UP	TV = PTFE ENCAP, FKM
	TSU = PTFE W/SANIFLEX™ BACK-UP (WHITE)	WF = WIL-FLEX™ [SANTOPRENE®]
	TWS = FULL-STROKE PTFE W/WIL-FLEX™ BACKUP	
	VTS = FKM (WHITE DOT)	
	WFS = WIL-FLEX™ [SANTOPRENE® (THREE BLACK DOTS)]	
	WWL = WIL-FLEX™ IPD [SANTOPRENE® (THREE BLACK DOTS)]	

SPECIALTY CODES

0100 Wil-Gard II™ 110V	0504 DIN flange
0102 Wil-Gard II™ sensor wires Only	0506 DIN flange, PFA coated hardware
0103 Wil-Gard II™ 220V	0603 PFA coated hardware, Wil-Gard II™ 110V
0206 PFA coated hardware, Wil-Gard II™ sensor wires ONLY	0604 DIN flange, Wil-Gard II™ 220V
0480 PCM I™ (Sensor & wires only)	0608 PFA coated hardware, Wil-Gard II™ 220V
0502 PFA coated hardware	0677 Center-Ported, NPT Inlet & Discharge

! NOTE: Most elastomeric materials use colored dots for identification. **! NOTE:** Not all models are available with all material options

SECTION 3

HOW IT WORKS – AIR-OPERATED DOUBLE-DIAPHRAGM PUMP

The Wilden diaphragm pump is an air-operated, positive displacement, self-priming pump. These drawings show flow pattern through the pump upon its initial stroke. It is assumed the pump has no fluid in it prior to its initial stroke.

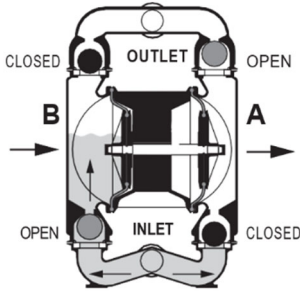

FIGURE 1 The air valve directs pressurized air to the back side of diaphragm A. The compressed air is applied directly to the liquid column separated by elastomeric diaphragms. The diaphragm acts as a separation membrane between the compressed air and liquid; a balanced load removes mechanical stress from the diaphragm. The compressed air moves the diaphragm away from the center of the pump. The opposite diaphragm is pulled in by the shaft connected to the pressurized diaphragm. Diaphragm B is on its suction stroke; air behind the diaphragm has been forced out to atmosphere through the exhaust port of the pump. The movement of diaphragm B toward the center of the pump creates a vacuum within chamber B. Atmospheric pressure forces fluid into the inlet manifold forcing the inlet valve ball off its seat. Liquid is free to move past the inlet valve ball and fill the liquid chamber (see shaded area).

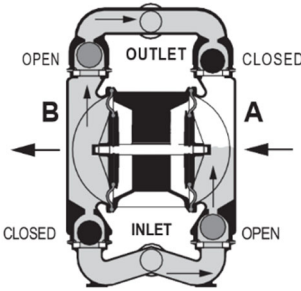

FIGURE 2 When the pressurized diaphragm, diaphragm A, reaches the limit of its discharge stroke, the air valve redirects pressurized air to the back side of diaphragm B. The pressurized air forces diaphragm B away from the center while pulling diaphragm A to the center. Diaphragm B is now on its discharge stroke. Diaphragm B forces the inlet valve ball onto its seat due to the hydraulic forces developed in the liquid chamber and manifold of the pump. These same hydraulic forces lift the discharge valve ball off its seat, while the opposite discharge valve ball is forced onto its seat, forcing fluid to flow through the pump discharge. The movement of diaphragm A toward the center of the pump creates a vacuum within liquid chamber A. Atmospheric pressure forces fluid into the inlet manifold of the pump. The inlet valve ball is forced off its seat allowing the fluid being pumped to fill the liquid chamber.

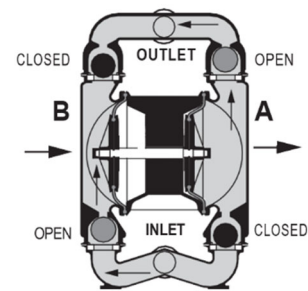
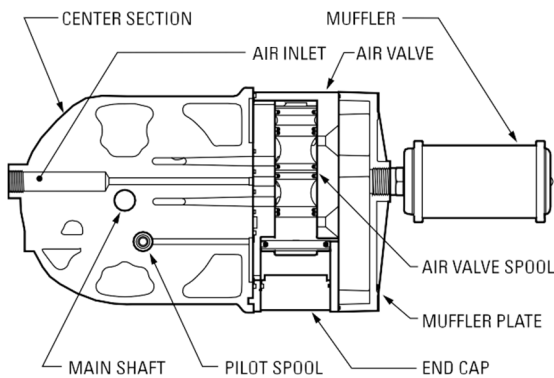

FIGURE 3 At completion of the stroke, the air valve again redirects air to the back side of diaphragm A, which starts diaphragm B on its exhaust stroke. As the pump reaches its original starting point, each diaphragm has gone through one exhaust and one discharge stroke. This constitutes one complete pumping cycle. The pump may take several cycles to completely prime depending on the conditions of the application.

HOW IT WORKS – AIR DISTRIBUTION SYSTEM



The Pro-Flo® patented air distribution system incorporates two moving parts: the air valve spool and the pilot spool. The heart of the system is the air valve spool and air valve. This valve design incorporates an unbalanced spool. The smaller end of the spool is pressurized continuously, while the large end is alternately pressurized then exhausted to move the spool. The spool directs pressurized air to one air chamber while exhausting the other. The air causes the main shaft/diaphragm assembly to shift to one side — discharging liquid on that side and pulling liquid in on the other side. When the shaft reaches the end of its stroke, the inner piston actuates the pilot spool, which pressurizes and exhausts the large end of the air valve spool. The repositioning of the air valve spool routes the air to the other air chamber

SECTION 4

DIMENSIONAL DRAWING

P200 Plastic – Polypropylene

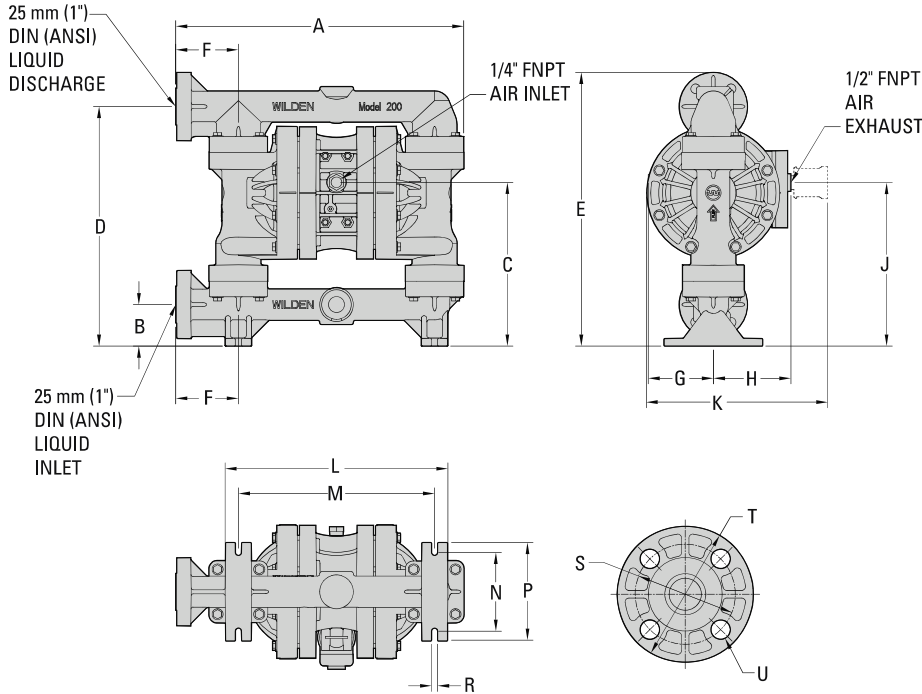

DIMENSIONS

ITEM	METRIC (mm)	STANDARD (inch)
A	457	18.0
B	66	2.6
C	259	10.2
D	381	15.0
E	434	17.1
F	99	3.9
G	104	4.1
H	122	4.8
J	259	10.2
K	288	11.3
L	353	13.9
M	310	12.2
N	124	4.9
P	157	6.2
R	10	0.4
DIN FLANGE		
S	85 DIA.	3.3 DIA.
T	115 DIA.	4.5 DIA.
U	15 DIA.	0.6 DIA.
ANSI FLANGE		
S	79 DIA.	3.1 DIA.
T	108 DIA.	4.3 DIA.
U	15 DIA.	0.6 DIA.

LW0345 REV. B

P200 Plastic – PVDF

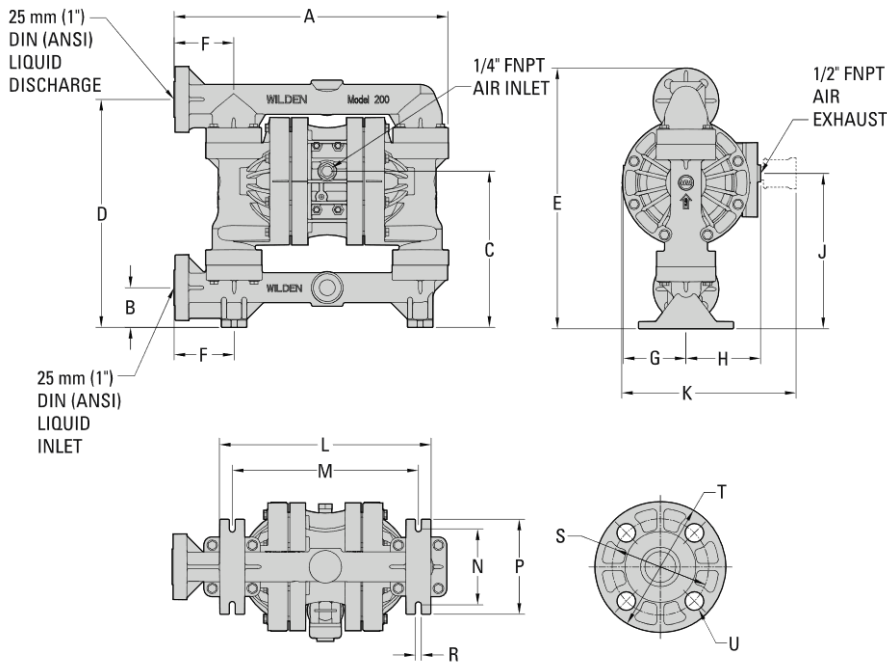

DIMENSIONS

ITEM	METRIC (mm)	STANDARD (inch)
A	452	17.8
B	66	2.6
C	257	10.1
D	376	14.8
E	429	16.9
F	99	3.9
G	104	4.1
H	122	4.8
J	257	10.1
K	288	11.3
L	353	13.9
M	310	12.2
N	124	4.9
P	157	6.2
R	10	0.4
DIN FLANGE		
S	84 DIA.	3.3 DIA.
T	115 DIA.	4.5 DIA.
U	15 DIA.	0.6 DIA.
ANSI FLANGE		
S	79 DIA.	3.1 DIA.
T	108 DIA.	4.3 DIA.
U	15 DIA.	0.6 DIA.

LW0346 REV. B

DIMENSIONAL DRAWING

P200 Plastic - Polypropylene, Center Ported

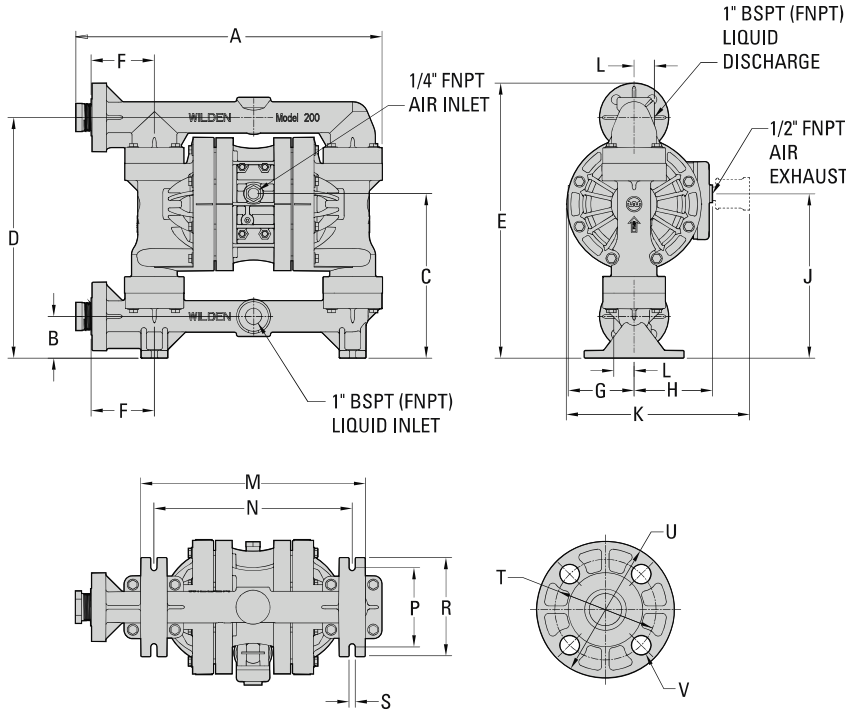

DIMENSIONS

ITEM	METRIC (mm)	STANDARD (inch)
A	480	18.9
B	66	2.6
C	259	10.2
D	381	15.0
E	434	17.1
F	99	3.9
G	104	4.1
H	122	4.8
J	259	10.2
K	288	11.3
L	32	1.3
M	353	13.9
N	310	12.2
P	124	4.9
R	157	6.2
S	10	0.4
DIN FLANGE		
T	85 DIA.	3.3 DIA.
U	115 DIA.	4.5 DIA.
V	14 DIA.	0.6 DIA.
ANSI FLANGE		
T	79 DIA.	3.1 DIA.
U	109 DIA.	4.3 DIA.
V	14 DIA.	0.6 DIA.

LW0492 REV. A

P200 Plastic - PVDF, Center Ported

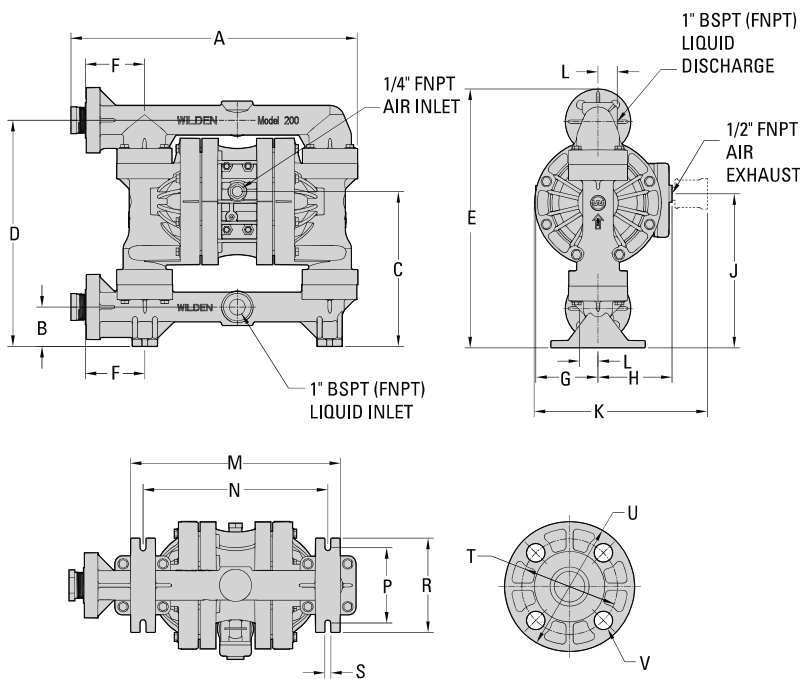

DIMENSIONS

ITEM	METRIC (mm)	STANDARD (inch)
A	476	18.7
B	66	2.6
C	257	10.1
D	376	14.8
E	429	16.9
F	99	3.9
G	104	4.1
H	122	4.8
J	257	10.1
K	288	11.3
L	32	1.3
M	353	13.9
N	310	12.2
P	124	4.9
R	157	6.2
S	10	0.4
DIN FLANGE		
T	84 DIA.	3.3 DIA.
U	114 DIA.	4.5 DIA.
V	15 DIA.	0.6 DIA.
ANSI FLANGE		
T	79 DIA.	3.1 DIA.
U	109 DIA.	4.3 DIA.
V	15 DIA.	0.6 DIA.

LW0493 REV. A

SECTION 5

PERFORMANCE

P200 PLASTIC RUBBER-FITTED

Ship Weights.....Polypropylene 10 kg (22 lb)
PVDF 15 kg (32 lb)
Air Inlet......6 mm (1/4")
Inlet......25 mm (1")
Outlet......25 mm (1")
Suction Lift.....3.6 m Dry (11.9')
9.1 m Wet (30.0')
Disp. per Stroke¹.....0.32 L (.086 gal)
Max. Flow Rate.....220 lpm (58 gpm)
Max. Size Solids.....4.76 mm (3/16")

¹Displacement per stroke was calculated at 4.8 bar (70 psig) air inlet pressure against a 2 bar (30 psig) head pressure.

Example: To pump 68 lpm (18 gpm) against a discharge head of 3.4 bar (50 psig) requires 4.1 bar (60 psig) and 34 Nm³/h (20 scfm) air consumption.

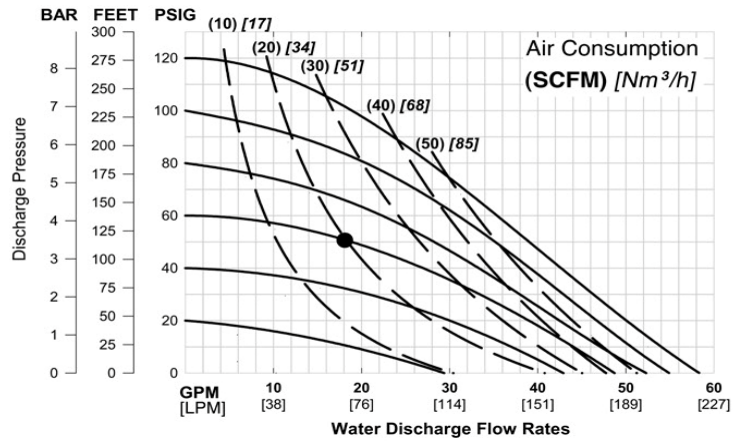

Flow rates indicated on chart were determined by pumping water. For optimum life and performance, pumps should be specified so that daily operation parameters will fall in the center of the pump's performance curve.

Caution: Do not exceed 8.6 bar (125 psig) air supply pressure on Polypropylene and PVDF pumps.

P200 PLASTIC TPE-FITTED

Ship Weights.....Polypropylene 10 kg (22 lb)
PVDF 15 kg (32 lb)
Air Inlet......6 mm (1/4")
Inlet......25 mm (1")
Outlet......25 mm (1")
Suction Lift.....3.6 m Dry (11.4')
9.8 m Wet (32.0')
Disp. per Stroke¹.....0.33 L (.088 gal)
Max. Flow Rate.....216 lpm (57 gpm)
Max. Size Solids.....4.76 mm (3/16")

¹Displacement per stroke was calculated at 4.8 bar (70 psig) air inlet pressure against a 2.1 bar (30 psig) head pressure.

Example: To pump 76 lpm (20 gpm) against a discharge head of 3.1 bar (45 psig) requires 4.1 bar (60 psig) and 34 Nm³/h (20 scfm) air consumption.

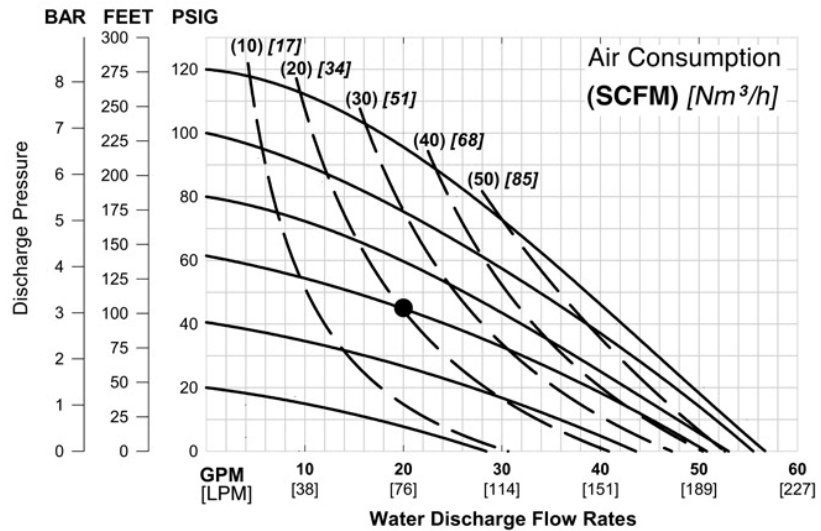

Flow rates indicated on chart were determined by pumping water. For optimum life and performance, pumps should be specified so that daily operation parameters will fall in the center of the pump's performance curve.

Caution: Do not exceed 8.6 bar (125 psig) air supply pressure on Polypropylene and PVDF pumps.

PERFORMANCE

**P200 PLASTIC
REDUCED-STROKE
PTFE-FITTED**

Ship Weights.....Polypropylene 10 kg (22 lb)
PVDF 15 kg (32 lb)
Air Inlet.....6 mm (1/4")
Inlet.....25 mm (1")
Outlet.....25 mm (1")
Suction Lift.....2.4 m Dry (7.9')
9.4 m Wet (31.0')
Disp. per Stroke¹.....0.22 L (.057 gal)
Max. Flow Rate.....174 lpm (46 gpm)
Max. Size Solids.....4.76 mm (3/16")

¹Displacement per stroke was calculated at 4.8 bar (70 psig) air inlet pressure against a 2.1 bar (30 psig) head pressure.

Example: To pump 76 lpm (20 gpm) against a discharge head of 4.5 bar (65 psig) requires 6.9 bar (100 psig) and 37 Nm³/h (40 scfm) air consumption.

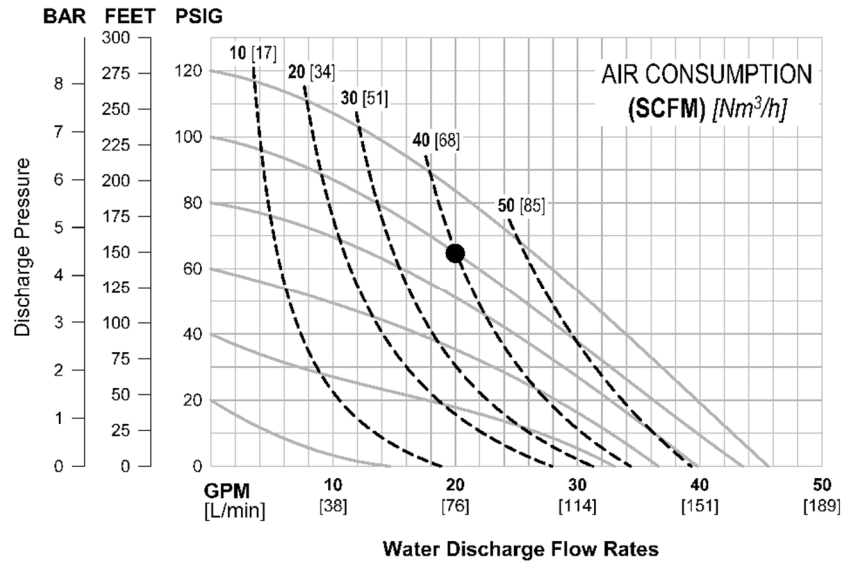

Flow rates indicated on chart were determined by pumping water. For optimum life and performance, pumps should be specified so that daily operation parameters will fall in the center of the pump's performance curve.

Caution: Do not exceed 8.6 bar (125 psig) air supply pressure on Polypropylene and PVDF pumps.

**P200 PLASTIC
FULL-STROKE
PTFE-FITTED**

Ship Weights.....Polypropylene 10 kg (22 lb)
PVDF 15 kg (32 lb)
Air Inlet.....6 mm (1/4")
Inlet.....25 mm (1")
Outlet.....25 mm (1")
Suction Lift.....3.5 m Dry (11.4')
8.6 m Wet (28.4')
Disp. per Stroke¹.....0.5 L (0.13 gal)
Max. Flow Rate.....182 lpm (48.1 gpm)
Max. Size Solids.....4.76 mm (3/16")

¹Displacement per stroke was calculated at 4.8 bar (70 psig) air inlet pressure against a 2.1 bar (30 psig) head pressure.

Example: To pump 125 lpm (33 gpm) against a discharge head of 1.4 bar (20 psig) requires 5.5 bar (80 psig) and 37 Nm³/h (40 scfm) air consumption.

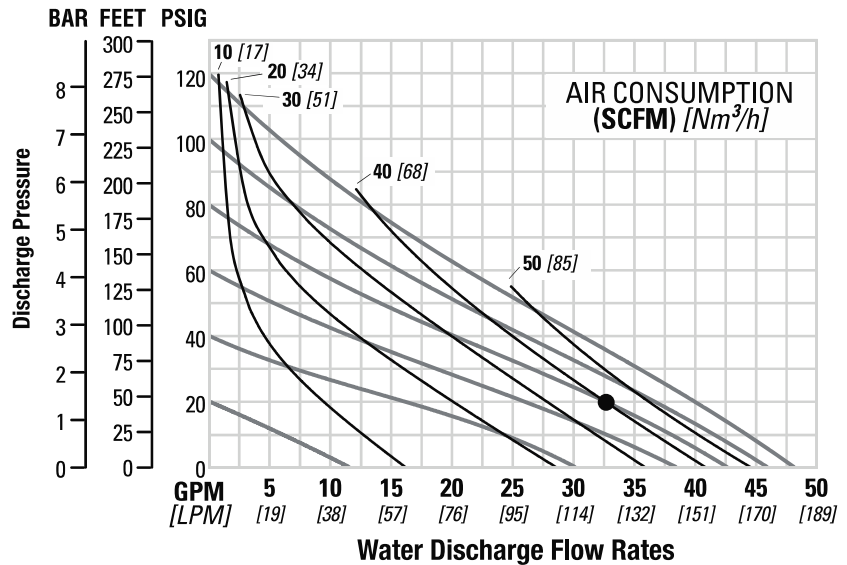

Flow rates indicated on chart were determined by pumping water. For optimum life and performance, pumps should be specified so that daily operation parameters will fall in the center of the pump's performance curve.

Caution: Do not exceed 8.6 bar (125 psig) air supply pressure on Polypropylene and PVDF pumps.

SECTION 5

SUCTION LIFT CAPABILITY

P200 PLASTIC SUCTION LIFT CAPABILITY

Suction-lift curves are calibrated for pumps operating at 305 m (1,000') above sea level. This chart is meant to be a guide only. There are many variables that can affect your pump's operating characteristics. The number of intake and discharge elbows, viscosity of pumping fluid, elevation (atmospheric pressure) and pipe friction loss all affect the amount of suction lift your pump will attain.

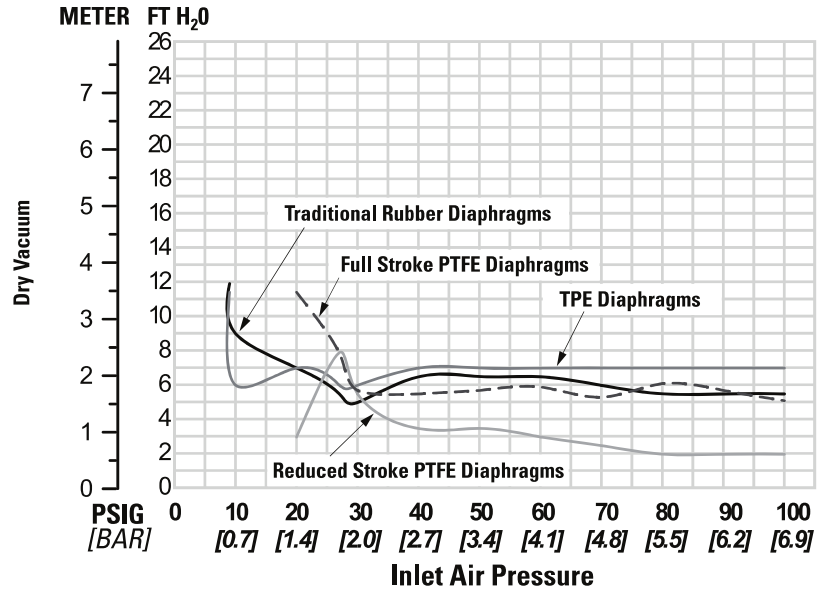

SECTION 6

**SUGGESTED INSTALLATION, OPERATION, MAINTENANCE
AND TROUBLESHOOTING**

Wilden pumps are designed to meet the performance requirements of even the most demanding pumping applications. They have been designed and manufactured to the highest standards and are available in a variety of liquid path materials to meet your chemical resistance needs. Refer to "Performance" for an in-depth analysis of the performance characteristics of your pump. Wilden offers the widest variety of elastomer options in the industry to satisfy temperature, chemical compatibility, abrasion resistance and flex concerns.

The suction pipe size should be at least equal to or larger than the diameter size of the suction inlet on your Wilden pump. The suction hose must be a non-collapsible, reinforced type because these pumps are capable of pulling a high vacuum. Discharge piping should also be equal to or larger than the diameter of the pump discharge, which will help reduce friction losses.

 **CAUTION:** All fittings and connections must be airtight. Otherwise, pump suction capability will be reduced or lost.

Months of careful planning, study and selection efforts can result in unsatisfactory pump performance if installation details are left to chance. You can avoid premature failure and long-term dissatisfaction by exercising reasonable care throughout the installation process.

Location

Noise, safety and other logistical factors usually dictate where equipment will be situated on the production floor. Multiple installations with conflicting requirements can result in congestion of utility areas, leaving few choices for additional pumps. Within the framework of these and other existing conditions, locate every pump in such a way that the following six key factors are balanced against each other to maximum advantage:

- **Access:** First, the location should be accessible. If it's easy to reach the pump, maintenance personnel will be able to perform routine inspections and adjustments more easily. If major repairs become necessary, ease of access can play a key role in speeding the repair process and reducing total downtime.
- **Air Supply:** Every pump location should have an air line large enough to supply the volume of air necessary to achieve the desired pumping rate. For best results, the pumps should use a 5µ (micron) air filter, needle valve and regulator. The use of an air filter before the pump will ensure that the majority of any pipeline contaminants will be eliminated.
- **Solenoid Operation:** When operation is controlled by a solenoid valve in the air line, three-way valves should be used. This valve allows trapped air between the valve and the pump to bleed off, which improves pump performance. You can estimate pumping volume by counting the number of strokes per minute, and then multiplying that figure by the displacement per stroke.
- **Muffler:** Using the standard Wilden muffler, sound levels are reduced below OSHA specifications. You can use other mufflers to reduce sound levels farther, but they usually reduce pump performance.
- **Elevation:** Selecting a site that is well within the pump's dynamic lift capability will assure that loss-of-prime issues will

be eliminated. In addition, pump efficiency can be adversely affected if proper attention is not given to site location.

- **Piping:** Final determination of the pump site should not be made until the piping challenges of each possible location have been evaluated. The impact of current and future installations should be considered ahead of time to make sure that inadvertent restrictions are not created for any remaining sites.

The best choice possible will be a site involving the shortest and straightest hook-up of suction and discharge piping. Unnecessary elbows, bends and fittings should be avoided. Pipe sizes should be selected to keep friction losses within practical limits. All piping should be supported independently of the pump. In addition, the piping should be aligned to avoid placing stress on the pump fittings.

Flexible hose can be installed to aid in absorbing the forces created by the natural reciprocating action of the pump. If the pump is to be bolted down to a solid location, a mounting pad placed between the pump and the foundation will assist in minimizing pump vibration. Flexible connections between the pump and rigid piping will also assist in minimizing pump vibration. If quick-closing valves are installed at any point in the discharge system, or if pulsation within a system becomes a problem, a surge suppressor (SD Equalizer) should be installed to protect the pump, piping and gauges from surges and water hammer.

If the pump is to be used in a self-priming application, make sure that all connections are airtight and that the suction lift is within the model's ability.

 **NOTE:** Materials of construction and elastomer material have an effect on suction lift parameters. Please refer to "Performance" for specifics.

When pumps are installed in applications involving flooded suction or suction head pressures, a gate valve should be installed in the suction line to permit closing of the line for pump service.

Pumps in service with a positive suction head are most efficient when inlet pressure is limited to 0.5–0.7 bar (7–10 psig). Premature diaphragm failure may occur if positive suction is 0.7 bar (10 psig) and higher.

 **CAUTION:** All Wilden pumps are capable of passing solids. Use a strainer on the pump intake to ensure that the pump's rated solids capacity is not exceeded.

 **CAUTION:** Do not exceed 8.6 bar (125 psig) air supply pressure.

 **CAUTION:** Pro-Flo® pumps are not submersible.

SUGGESTED INSTALLATION, OPERATION, MAINTENANCE AND TROUBLESHOOTING

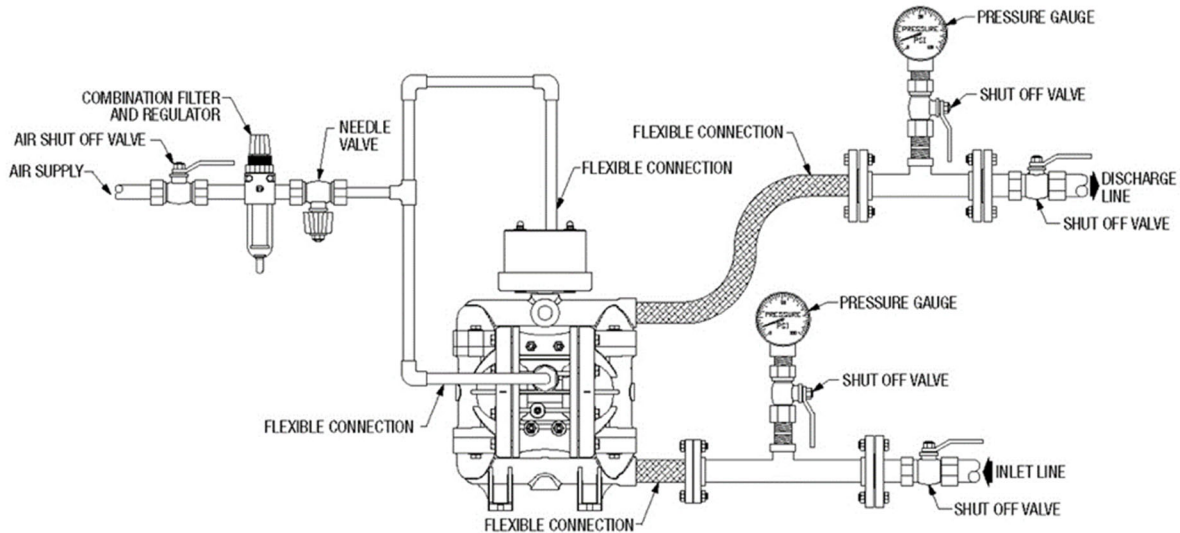

! **NOTE:** In the event of a power failure, close the shut-off valve if you do not want the pump to restart when the power returns.

Air-Operated Pumps: To stop the pump from operating in an emergency, simply close the shut-off valve (user-supplied) installed in the air supply line. A properly functioning valve will stop the air supply to the pump, therefore stopping output. This shut-off valve should be located far enough away from the pumping equipment such that it can be reached safely in an emergency.

Operation

The Pro-Flo pumps are pre-lubricated and do not require in-line lubrication. Additional lubrication will not damage the pump. However, if the pump is heavily lubricated by an external source, the pump's internal lubrication may be washed away. If the pump is then moved to a nonlubricated location, it may need to be disassembled and re-lubricated as described in "Disassembly/ Reassembly".

Pump discharge rate can be controlled by limiting the volume and/or pressure of the air supply to the pump. An air regulator is used to regulate air pressure. A needle valve is used to regulate volume. Pump discharge rate also can be controlled by throttling the pump discharge by partially closing a valve in the discharge line of the pump. This action increases friction loss, which reduces flow rate. (See "Performance") This is useful when the need exists to control the pump from a remote location. When the pump discharge pressure equals or exceeds the air supply pressure, the pump will stop. No bypass or pressure relief valve is needed, and

pump damage will not occur. The pump has reached a "deadhead" situation and can be restarted by reducing the fluid discharge pressure or increasing the air inlet pressure. Wilden Pro-Flo pumps run solely on compressed air and do not generate heat. Therefore, your process fluid temperature will not be affected.

Maintenance and Inspections

Because each application is unique, maintenance schedules may be different for every pump. Frequency of use, line pressure, viscosity and abrasiveness of process fluid all affect the parts life of a Wilden pump. Periodic inspections have been found to offer the best means for preventing unscheduled pump downtime. Personnel familiar with the pump's construction and service should be informed of any abnormalities that are detected during operation.

SUGGESTED INSTALLATION, OPERATION, MAINTENANCE AND TROUBLESHOOTING

Troubleshooting

Pump will not run or runs slowly.

1. Remove plug from pilot spool exhaust.
2. Ensure that the air inlet pressure is at least 0.4 bar (5 psig) above startup pressure and that the differential pressure (the difference between air inlet and liquid discharge pressures) is not less than 0.7 bar (10 psig).
3. Check air inlet filter for debris (see "Suggested Installation, Operation, Maintenance and Troubleshooting").
4. Check for extreme air leakage (blow by) that would indicate worn seals/bores in the air valve, pilot spool and main shaft.
5. Disassemble the pump and check for obstructions in the air passageways or objects that would obstruct the movement of internal parts.
6. Check for sticking ball check valves.
 - a. If material being pumped is not compatible with pump elastomers, swelling may occur. Replace ball check valves and seals with proper elastomers.
 - b. Also, as the check valve balls wear out, they become smaller and can become stuck in the seats. In this case, replace balls and seats.
7. Check for any broken inner piston that would cause the air valve spool to be unable to shift.

Pump runs, but little or no product flows.

1. Check for pump cavitation. Slow pump speed down to allow thick material to flow into liquid chambers.
2. Verify that vacuum required to lift liquid is not greater than the vapor pressure of the material being pumped (cavitation).
3. Check for sticking ball check valves.
 - a. If material being pumped is not compatible with pump elastomers, swelling may occur. Replace ball check valves and seals with proper elastomers.
 - b. Also, as the check valve balls wear out, they become smaller and can become stuck in the seats. In this case, replace balls and seats.

Pump air valve freezes.

1. Check for excessive moisture in the compressed air.
 - a. Either install a dryer or a hot air generator for compressed air.
 - b. Alternatively, you may use coalescing filter to remove the water from the compressed air in some applications.

Air bubbles in pump discharge.

1. Check for a ruptured diaphragm.
2. Check tightness of outer pistons (see "Disassembly/Reassembly").
3. Check tightness of fasteners and integrity of O-rings and seals, especially at intake manifold.
4. Ensure pipe connections are airtight.

Product comes out air exhaust.

1. Check for a diaphragm rupture.
2. Check the tightness of the outer pistons to the shaft.

SECTION 7

DISASSEMBLY / REASSEMBLY

PUMP DISASSEMBLY

Tools Required:

- 1/2" Box Wrench
- 2 - 1" Socket or Adjustable Wrench
- Adjustable Wrench
- Vise equipped with soft jaws (such as plywood, plastic or other suitable material)



CAUTION: Before attempting any maintenance or repair, disconnect the compressed air line to the pump and allow all air pressure to bleed from the pump. Disconnect all intake, discharge, and air lines. Drain the pump by turning it upside down and allowing any fluid to flow into a suitable container. Be aware of any hazardous effects of contact with your process fluid.



NOTE: The model used for these instructions incorporates PTFE diaphragms and balls. Models with rubber diaphragms and balls are the same except where noted.



NOTE: Replace worn parts with genuine Wilden parts for reliable performance.

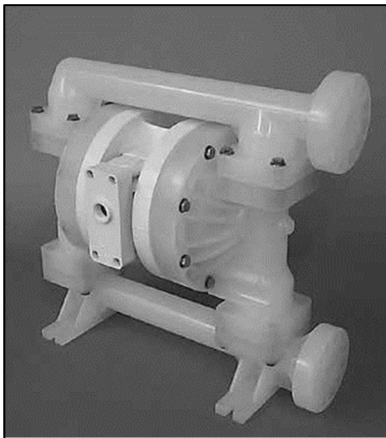

Step 1

Please see pre-molded alignment marks on the liquid chamber and center section.

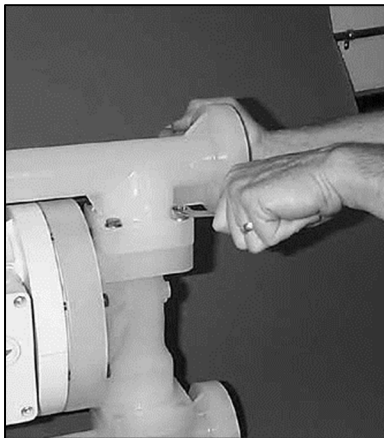

Step 2

Using the 13 mm (1/2") box wrench, loosen the discharge manifold from the liquid chambers.

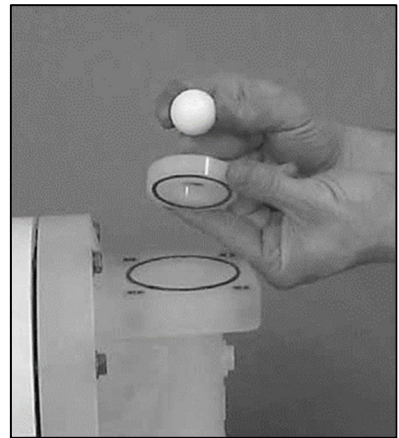

Step 3

Using the 13 mm (1/2") box wrench, loosen the discharge manifold from the liquid chambers

DISASSEMBLY / REASSEMBLY

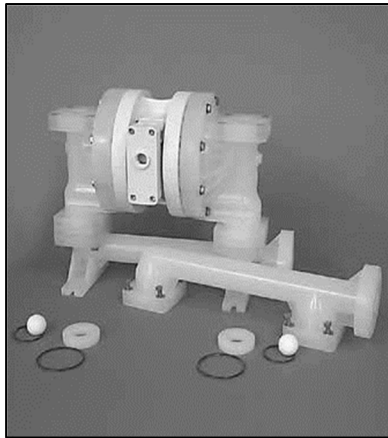

Step 4

Remove the discharge valve balls, seats and valve seat O-rings from the discharge manifold and liquid chamber, inspect for nicks, gouges, chemical attack or abrasive wear. Replace worn parts with genuine Wilden parts for reliable performance.

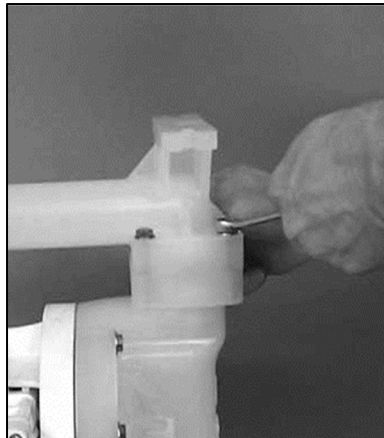

Step 5

Using a 13 mm (1/2") wrench, remove the inlet manifold.

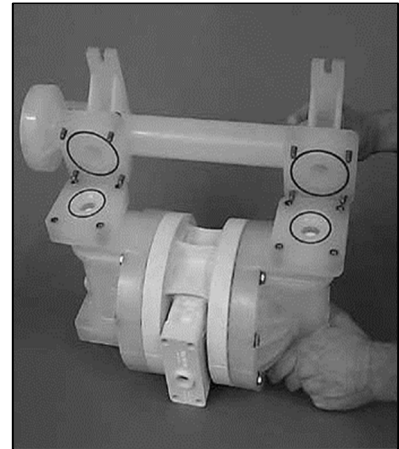

Step 6

Remove the inlet valve balls, seats and valve seat O-rings from the liquid chamber and inlet manifold, inspect for nicks, gouges, chemical attack or abrasive wear.

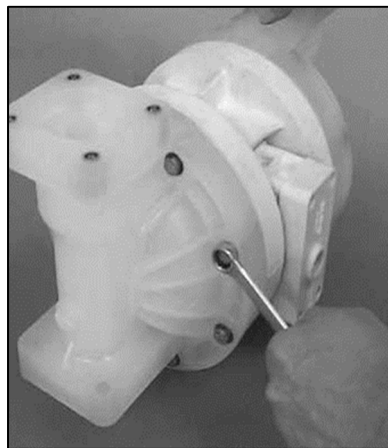

Step 7

Using a 13 mm (1/2") wrench, remove the liquid chambers from the center section.



Step 8

The liquid chamber should be removed to expose the diaphragm and outer piston. Rotate center section and remove the opposite liquid chamber.

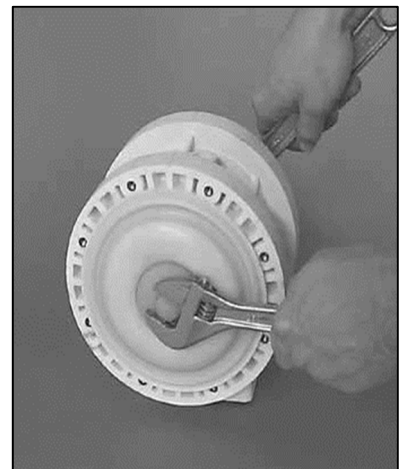

Step 9

Using two adjustable wrenches or 25 mm (1") sockets, remove diaphragm assembly from center section assembly.

DISASSEMBLY / REASSEMBLY

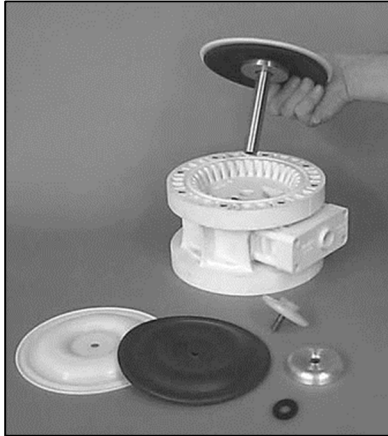

Step 10

After loosening and removing the outer piston the diaphragm assembly can be disassembled.



Step 11

To remove the remaining diaphragm assembly from the shaft, secure shaft with soft jaws (a vise fitted with plywood or other suitable material) to ensure shaft is not nicked, scratched, or gouged. Using an adjustable wrench, remove diaphragm assembly from shaft. Inspect all parts for wear and replace with genuine Wilden parts if necessary

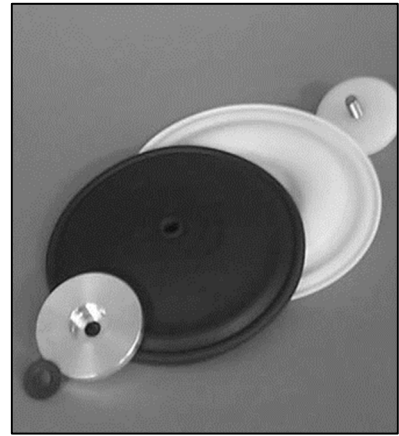

Step 12

Inspect diaphragms, outer and inner pistons for signs of wear. Replace with genuine Wilden parts if necessary.

DISASSEMBLY / REASSEMBLY

AIR VALVE DISASSEMBLY

Tools Required:

- 3/16" Allen Wrench
- Snap-Ring Pliers
- O-Ring Pick



CAUTION: Before attempting any maintenance or repair, disconnect the compressed air line to the pump and allow all air pressure to bleed from the pump. Disconnect all intake, discharge, and air lines. Drain the pump by turning it upside down and allowing any fluid to flow into a suitable container. Be aware of any hazardous effects of contact with your process fluid.

The Wilden P200 plastic pump uses the revolutionary Pro-Flo® air distribution system. A 6 mm (1/4") air inlet connects the air supply to the center section. Proprietary composite seals reduce the coefficient of friction and allow the pump to run lube-free. Constructed of polypropylene, the Pro-Flo® air distribution system is designed to perform in on/off, non-freezing, non-stalling, tough duty applications.



NOTE: Replace worn parts with genuine Wilden parts for reliable performance.



NOTE: For pump Air Valves fitted with Pump Cycle Monitor (PCMI) units, if the Set Screw is removed from the Air Valve Spool and/or the Sensor is removed from the Air Valve End Cap, refer to PCMI EOM WIL-19130-E for reassembly instructions.

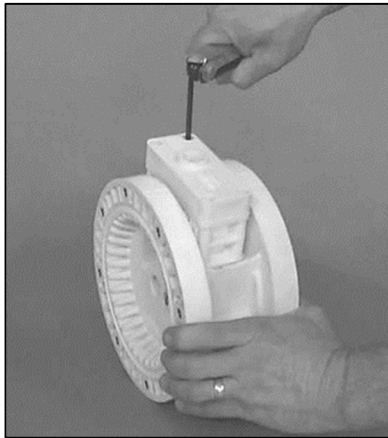

Step 1

Loosen the air valve bolts utilizing a 5 mm (3/16") Allen wrench.

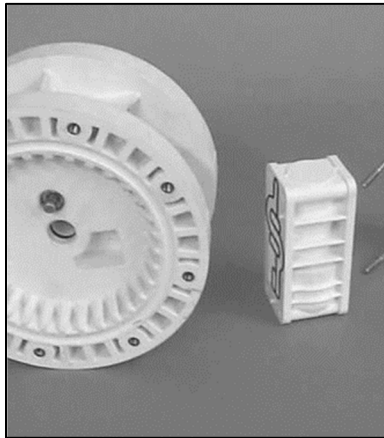

Step 2

Remove muffer plate and air valve bolts from air valve assembly exposing muffer gasket for inspection. Replace if necessary.



Step 3

Lift away air valve assembly and remove air valve gasket for inspection. Replace if necessary.

DISASSEMBLY / REASSEMBLY

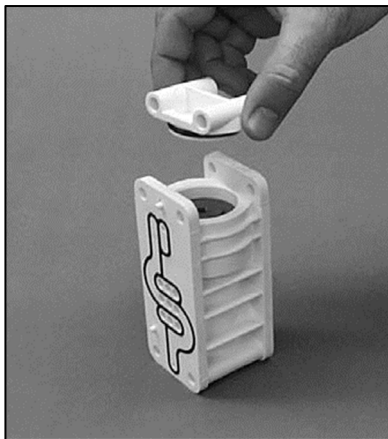

Step 4

Remove air valve end cap to expose air valve spool by simply lifting up on end cap once air valve bolts are removed.

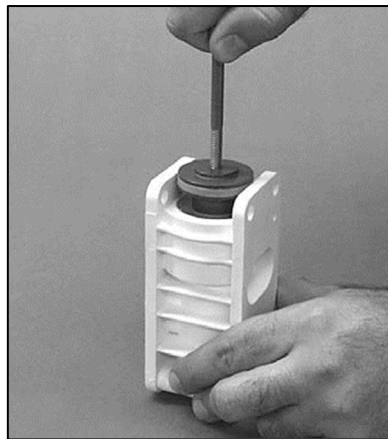

Step 5

Remove air valve spool from air valve body by threading one air valve bolt into the end of the spool and gently sliding the spool out of the air valve body. Inspect seals for signs of wear and replace entire assembly if necessary. Use caution when handling air valve spool to prevent damaging seals.

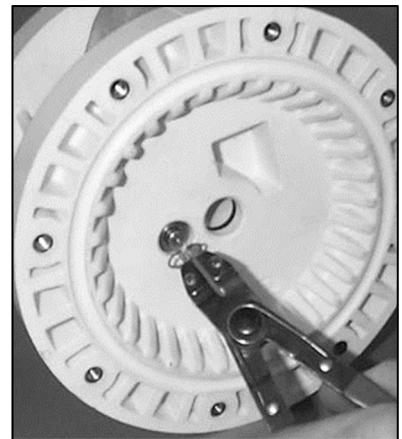

Step 6

Remove pilot spool sleeve retaining snap ring on both sides of center section with snap ring pliers.

NOTE: Seals should not be removed from assembly. Seals are not sold separately.

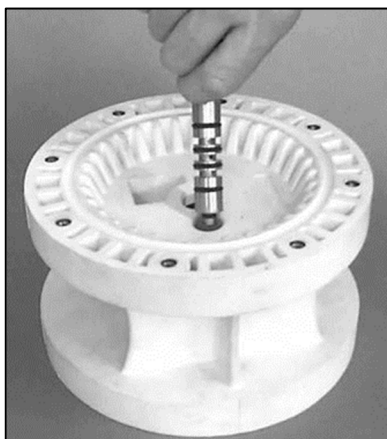

Step 7

Remove pilot spool sleeve from center section.

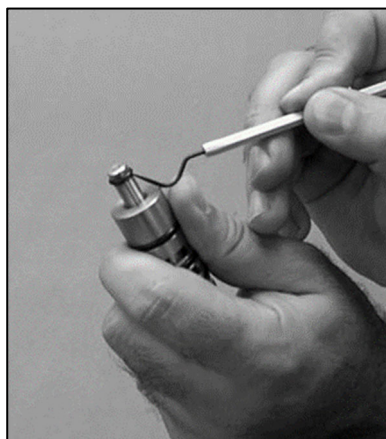

Step 8

With O-ring pick, gently remove the o- ring from the opposite side of the "center hole" cut on the spool. Gently remove the pilot spool from sleeve and inspect for nicks or gouges and other signs of wear. Replace pilot sleeve assembly or outer sleeve O-rings if necessary. During re-assembly never insert the pilot spool into the sleeve with the "center cut" side first, this end incorporates the urethane O-ring and will be damaged as it slides over the ports cut in the sleeve.

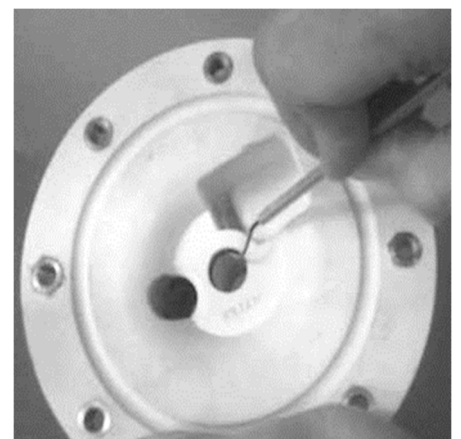

Step 9

Check center section Glyd™ rings for signs of wear. If necessary, remove Glyd™ rings with O-ring pick and replace.

DISASSEMBLY / REASSEMBLY

REASSEMBLY HINTS AND TIPS

Upon performing applicable maintenance to the air distribution system, the pump can now be reassembled. Please refer to the disassembly instructions for photos and parts placement.

To reassemble the pump, follow the disassembly instructions in reverse order. The air distribution system needs to be assembled first then the diaphragms and finally the wetted path. The applicable torque specifications are on this page.

The following tips will assist in the assembly process:

- Clean the inside of the center section shaft bore to ensure no damage is done to new seals.
- Stainless bolts should be lubed to reduce the possibility of seizing during tightening.
- Be sure to tighten outer pistons simultaneously on PTFE-fitted pumps to ensure proper torque values.
- Apply two (2) drops of Loctite® 246 to the shaft internal threads before the diaphragm assembly.
- Concave side of disc spring in diaphragm assembly faces toward inner piston.

Maximum Torque Specifications	
Description	Torque
Pro-Flo® Air Valve	3.1 N·m (27 in-lb)
Air Inlet Reducer Bushing	0.9 N·m (8 in-lb)
Outer Pistons, All diaphragms	27.1 N·m (20 ft-lb)
Top and Bottom Manifold (Poly & PVDF)	5.1 N·m (45 in-lb)
Liquid Chamber (Poly & PVDF)	8.5 N·m (75 in-lb)

DISASSEMBLY / REASSEMBLY

SHAFT SEAL INSTALLATION

Pre-Installation

After all the old seals have been removed, the inside of the bushing should be cleaned to ensure no debris is left that may cause premature damage to the new seals.

Installation

1. To prevent damaging the inside surface of the new seal, wrap electrical tape around each leg of the needle-nose pliers. (Heat shrink tubing may also be used.)
2. With a new seal in hand, place the two legs of the needle-nose pliers inside the seal ring. (See Figure A.)
3. Open the pliers as wide as the seal diameter will allow, then with two fingers pull down on the top portion of the seal to form a kidney bean shape. (See Figure B.)
4. Lightly clamp the pliers together to hold the seal into the kidney shape. Be sure to pull the seal into as tight of a kidney shape as possible. This will allow the seal to travel down the bushing bore with greater ease.
5. With the seal clamped in the pliers, insert the seal into the bushing bore and position the bottom of the seal into the correct groove. When the bottom of the seal is seated in the groove, release the clamp pressure on the pliers. This will allow the seal to partially snap back to its original shape.
6. After removing the pliers, you will notice a slight bump in the seal shape. Before the seal can be resized properly, the bump in the seal should be removed as much as possible. This can be done with either a Phillips screwdriver or your finger. With the side of the screwdriver or your finger, apply light pressure to the peak of the bump. This pressure will cause the bump to be eliminated almost completely.
7. Lubricate the edge of the shaft with NLGI grade 2 white EP bearing grease.
8. Slowly insert the center shaft with a rotating motion. This will complete the resizing of the seal.
9. Repeat these steps for the remaining seals.

Tools

The following tools can be used to aid in the installation of the new seals:

- Needle-Nose Pliers
- Phillips Screwdriver
- Electrical Tape

Figure A

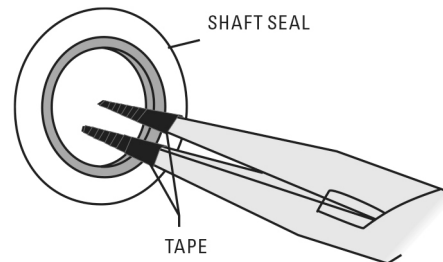
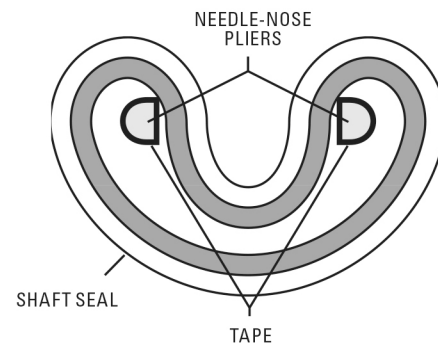

Figure B



SECTION 8

EXPLODED VIEW AND PARTS LIST

P200 PLASTIC

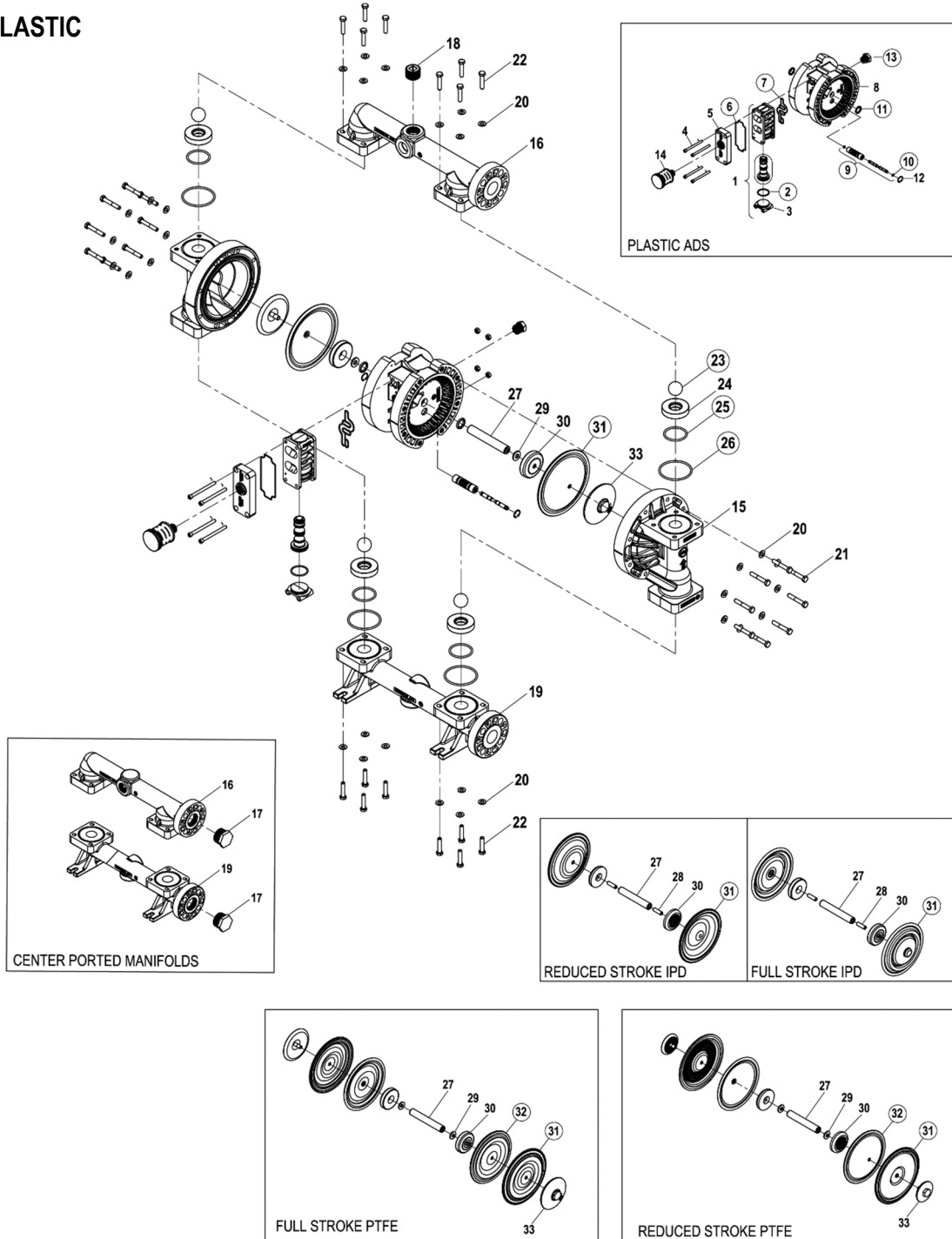

ALL CIRCLED PART IDENTIFIERS ARE INCLUDED IN REPAIR KITS

LW0490 REV. B

EXPLODED VIEW AND PARTS LIST

Item	Description	Qty.	P200/PKPPP/.../ P/N	P200/ PKPPP/.../0502 P/N	P200/KKPPP/.../ P/N	P200/KKPPP/.../0502 P/N
Air Distribution Components						
1	Air Valve Assembly Pro-Flo™¹	1			01-2010-20	
2	End Cap	1			01-2332-20	
3	O-Ring, (-126), End Cap (Ø1.362 x Ø.103)	1			01-2395-52	
4	Gasket, Air Valve, Pro-Flo™	1			01-2615-52	
5	Gasket, Muffler Plate, Pro-Flo™	1			01-3505-52	
6	Muffler Plate, Pro-Flo®	1			01-3181-20	
7	Screw, SHC, Air Valve (1/4"-20 x 3")	4	01-6001-03	01-6001-05	01-6001-03	01-6001-05
8	Center Section Assembly, Pro-Flo™ ²	1			02-3142-20	
9	Assembly, Pilot Sleeve	1			02-3880-99	
10	PilotSpoolRetainingO-Ring(-009.Ø.208xØ.070)	2			04-2650-49-700	
11	Shaft Seal	2			02-3210-55-225	
12	Retaining Ring	2			00-2650-03	
13	Bushing, Reducer, 1/2" MNPT to 1/4" FNPT	1			01-6950-20	
14	Muffler, 1/2" MNPT	1			02-3510-99	
Wetted Path Components						
15	Chamber, Liquid	2		02-5005-20		02-5005-21
16	Manifold, Discharge (ANSI)	1		02-5030-20		02-5030-21
	Manifold, Discharge (DIN)	1		02-5031-20		02-5031-21
	Manifold, Discharge Center Ported (NPT)	1		02-5030-20-677		02-5030-21-677
	Manifold, Discharge Center Ported (BSPT)	1		02-5031-20-678		02-5031-21-678
17	Pipe Plug, 1-1/4" NPT (Center Ported Only)	2		02-7012-20		02-7012-21
18	Pipe Plug, 1" NPT	1		02-7013-20		
19	Manifold, Inlet (ANSI)	1		02-5090-20		02-5090-21
	Manifold, Inlet (DIN)	1		02-5091-20		02-5091-21
	Manifold, Inlet Center Ported (NPT)	1		02-5090-20-677		02-5090-21-677
	Manifold, Inlet Center Ported (BSPT)	1		02-5091-20-678		02-5091-21-678
20	Washer, (.344 I.D. x .688 O.D. x .065 THK.)	32	02-6731-03	02-6731-05	02-6731-03	02-6731-05
21	Bolt, HHCS, (5/16"-18 x 2")	16	02-6191-03	02-6191-05	02-6191-03	02-6191-05
22	Bolt, HHCS, (5/16"-18 x 1-1/2")	16	02-6181-03	02-6181-05	02-6181-03	02-6181-05
Valve Balls/Valve Seats/Valve O-Rings/Manifold O-Ring						
23	Ball, Valve	4			*	
24	Seat, Valve	4		02-1125-20		02-1125-21
25	O-ring, (-225), Valve Seat (Ø1.859 x Ø.139)	4			*	
26	O-ring, (-232), Manifold (Ø2.734 x Ø.139)	4			*	
Full-Stroke Rubber/TPE/PTFE/FSIPD Components						
27	Shaft	1			02-3810-03	
28	Stud, 3/8"-16 x 1 1/4"	2			02-6150-08	
29	Disc Spring	2			02-6802-08	
30	Inner Piston	2			02-3701-01	
31	Diaphragm, Primary	2			*	
	Diaphragm, IPD Primary	2			*	
32	Diaphragm, Back-Up	2			*	
33	Outer Piston	2			02-4550-21-500	
Reduced-Stroke PTFE Components						
27	Shaft, Reduced Stroke PTFE	1			02-3840-03	
28	Stud, 3/8"-16 x 1 1/4"	2			02-6150-08	
29	Disc Spring	2			02-6802-08	
30	Inner Piston, Reduced Stroke PTFE	2			02-3751-01	
31	Diaphragm, Primary, Reduced Stroke PTFE	2			*	
	Diaphragm, IPD Primary, Reduced Stroke PTFE	2			*	
32	Diaphragm, Back-Up, Reduced Stroke PTFE	2			*	
33	Outer Piston, Reduced Stroke PTFE	2			02-4600-21-500	

LW0491 Rev. D

*Refer to Elastomer Options.

¹Air Valve Assembly includes item numbers 2 and 3.

²Center Section Assembly includes items numbers 11 and 13.

All boldface items are primary wear parts

SECTION 9

ELASTOMER OPTIONS

P200 PLASTIC

MATERIAL	DIAPHRAGMS (2)	FULL-STROKE DIAPHRAGMS (2)	FULL-STROKE BACK-UP DIAPHRAGMS (2)	FULL-STROKE IPD DIAPHRAGMS (2)	REDUCED STROKE DIAPHRAGMS (2)	REDUCED STROKE BACK-UP DIAPHRAGMS (2)	REDUCED STROKE IPD DIAPHRAGMS (2)	VALVE BALLS (4)	VALVE SEATS (4)	VALVE SEAT O-RINGS (4)	MANIFOLD O-RINGS (4)
Polyurethane	02-1010-50							02-1085-50		02-1220-50	04-1300-50-500
Neoprene	02-1010-51					02-1060-51		02-1085-51			
Buna-N®	02-1010-52							02-1085-52		04-2390-52-700	04-1300-52-500
Conductive Buna-N®	02-1010-86										
FKM	02-1010-53							02-1085-53			
EPDM	02-1010-54					02-1060-54		02-1085-54			
PTFE		02-1040-55			02-1010-55		02-1010-72-85	02-1085-55	02-1125-55		
PTFE Encapsulated FKM										02-1220-60	04-1300-60-500
Non-Food Grade Saniflex				02-1031-46							
Saniflex™	02-1010-56		02-1065-56	02-1031-56		02-1060-56		02-1085-56			
Wil-Flex™	02-1010-58			02-1031-58				02-1085-58		02-1220-58	02-1370-58
Food Grade Wil-Flex™	02-1010-57		02-1065-57	02-1031-57							
Polypropylene									02-1125-20		
PVDF									02-1125-21		

LW0491 Rev. D

NOTES

NOTES

NOTES

WILDEN®

PSG
22069 Van Buren Street
Grand Terrace, CA 92313-5651 USA
P: +1 (909) 422 -1730
psgdover.com



Where Innovation Flows

Copyright 2021 PSG®, a Dover® Company
PSG® reserves the right to modify the information and illustrations contained in this document without prior notice. This is a non-contractual document.